

# **DM-IIIS**

# **User's Manual**





**CONTENTS:**

1. PRECAUTIONS AND SAFETY MEASURES.....	3
1.1. General.....	3
1.2. Preliminary instructions.....	3
1.3. During use.....	4
1.4. After use.....	4
2. GENERAL DESCRIPTION .....	5
2.1. Introduction.....	5
2.2. Functions.....	5
2.3. Initial screen .....	5
3. PREPARING THE INSTRUMENT .....	6
3.1. Initial check.....	6
3.2. Instrument power supply.....	6
3.3. Calibration .....	6
3.4. Storage.....	6
4. HOW TO OPERATE .....	7
4.1. Instrument: description .....	7
4.2. Keyboard: description.....	7
4.3. Display: description .....	8
4.4. Backlight function .....	8
5. MENU GENERAL .....	9
5.1. Initial settings.....	9
5.1.1. How to adjust the contrast.....	9
5.1.2. How to set date and time .....	9
5.1.3. How to set the language .....	9
5.2. Basic setting: analyzer config .....	10
5.2.1. How to set the type of electrical system under test.....	10
5.2.2. How to set the fundamental frequency.....	10
5.2.3. How to set the current range.....	10
5.2.4. How to set the clamp type.....	11
5.2.5. How to set the value of the transformer voltage ratio (TV RATIO) .....	11
5.2.6. How to enable/disable the password .....	11
5.3. Basic setting: recorder config .....	12
5.4. Analyzer memory.....	19
5.5. Reset.....	20
6. SWITCH FUNCTIONS.....	21
6.1. Position "VOLTAGE" .....	22
6.1.1. Symbols.....	22
6.1.2. "METER" mode.....	23
6.1.3. "HARM" mode.....	24
6.1.4. "WAVE" mode.....	25
6.2. Position "CURRENT" .....	26
6.2.1. Symbols.....	26
6.2.2. "METER" mode.....	27
6.2.3. "HARM" mode.....	28
6.2.4. "WAVE" mode.....	29
6.3. Position "POWER".....	30
6.3.1. Symbols.....	30
6.3.2. "METER" mode.....	31
6.3.3. "WAVE" mode.....	33
6.4. Position "ENERGY" .....	34
6.4.1. Symbols.....	34

6.4.2. "METER" mode .....	35
7. STARTING A RECORDING .....	36
8. DURING A RECORDING .....	38
9. STOPPING A RECORDING OR AN ENERGY MEASUREMENT .....	39
10. CONNECTING THE INSTRUMENT TO A PC .....	40
11. MEASURING PROCEDURES .....	41
11.1. Hints for flexible clamps use .....	41
11.2. Using the instrument in a single phase system .....	42
11.3. Using the instrument in a three phase 4 wire system .....	43
11.4. Using the instrument in a three phase 3 wire system .....	44
12. MAINTENANCE .....	46
12.1. General .....	46
12.2. Battery replacement .....	46
12.3. Cleaning .....	46
13. TECHNICAL SPECIFICATIONS .....	47
13.1. Features .....	47
13.1.1. Voltage measurement (autoranging) .....	47
13.1.2. Voltage anomalies detection (manual selection of range) .....	47
13.1.3. Current measurement (using external transducer) .....	47
13.1.4. Power measurement ( $\cos\varphi$ : 0.5c – 0.5i) .....	47
13.1.5. $\cos\varphi$ measurement .....	47
13.1.6. Measurement of harmonics .....	48
13.1.7. Frequency measurement .....	48
13.1.8. Compliance .....	48
13.1.9. Temperature drift .....	48
13.1.10. Safety .....	48
13.1.11. General characteristics .....	49
13.2. ENVIRONMENT .....	49
13.2.1. Operating conditions .....	49
13.2.2. EMC .....	49
13.3. ACCESSORIES .....	49
13.3.1. Standard accessories .....	49
14. APPENDIX 1 – MESSAGES DISPLAYED .....	50
15. APPENDIX 2 – RECORDABLE PARAMETERS: SYMBOLS .....	51
16. APPENDIX 3 – THEORETICAL OUTLINES .....	52
16.1. Voltage anomalies (voltage sag and surge) .....	52
16.2. Voltage and current harmonics .....	52
16.2.1. Theory .....	52
16.2.2. Limit values for harmonics .....	53
16.2.3. Presence of harmonics: causes .....	54
16.2.4. Presence of harmonics: consequences .....	54
16.3. Power and power factor: definitions .....	55
16.3.1. Conventions on powers and power factors .....	56
16.3.2. 3 phase 3 wire system .....	57
16.4. Measuring method: outlines .....	58
16.4.1. Integration periods .....	58
16.4.2. Power factor calculations .....	58
17. AFTER-SALE SERVICE .....	59
17.1. Warranty .....	59
17.2. Service .....	59

## 1. PRECAUTIONS AND SAFETY MEASURES

### 1.1. GENERAL

This instrument has been designed in compliance with EN 61010 directive. For your own safety and to avoid damaging the instrument we suggest you follow the procedures hereby prescribed and to read carefully all the notes preceded by the symbol .

Before and during measurements please be very diligent in following instructions below:

- ✓ Do not measure voltage or current in wet or dusty places;
- ✓ Do not measure in presence of gas, explosive materials or combustibles;
- ✓ Do not touch the circuit under test if no measurement is being taken;
- ✓ Do not touch exposed metal parts, unused terminals, circuits and so on;
- ✓ Do not use the instrument if it seems to be malfunctioning (i.e. if you notice deformations, breaks, leakage of substances, absence of messages on the display and so on);
- ✓ Use only cables and accessories approved by Amprobe.

The following symbols are used in this manual:



Caution: keep to what prescribed by the manual. An incorrect use could damage the instrument or its components



High voltage: risk of electric shock

### 1.2. PRELIMINARY INSTRUCTIONS

- ✓ This instrument has been designed for use in places with pollution class 2.
- ✓ It can be used for **voltage and current** measurements in installations of excess voltage category III 635 V~ phase to phase / 370 V~ phase to earth up to (and no more than) 2000 meters altitude.
- ✓ Please keep to the usual safety standards aimed at:
  - ◆ Protecting against dangerous currents;
  - ◆ Protecting the instrument against incorrect operations.
- ✓ Only the accessories supplied with the instrument guarantee compliance with the safety standards. Accordingly, they must be in good conditions and, if necessary, they must be replaced with identical models.
- ✓ Do not take measurements on circuits exceeding the specified current and voltage limits.
- ✓ Before connecting cables, alligator clips and clamps to the circuit under test, make sure that the right function has been selected.

### 1.3. DURING USE

Please read carefully:



#### CAUTION

Should you fail to keep to the prescribed instructions you could damage the instrument and/or its components or endanger your safety.

- ✓ When the instrument is connected to the circuit under test, do not touch any unused terminal.
- ✓ When measuring current, other currents located near the leads may affect the measuring accuracy.
- ✓ When measuring current, always position the wire in the very middle of the jaws in order to obtain the highest accuracy.
- ✓ A measured value remains constant if the "**HOLD**" function is active. Should you notice that the measured value remains unchanged, disable the "**HOLD**" function.

### 1.4. AFTER USE

- ✓ After use, turn off the instrument by pressing ON/OFF for a few seconds.
- ✓ If you will not be using the instrument for long periods of time use the storage instructions described at paragraph 3.4.

## 2. GENERAL DESCRIPTION

### 2.1. INTRODUCTION

The DM-IIIS represents a new approach to the world of electrical measurement. Computer assisted instruments such as the DM-IIIS permit an easy and fast analysis of a huge quantity of data.

### 2.2. FUNCTIONS

The DM-IIIS is able to:

- ✓ **display in real time** the electrical parameters of a single phase and three-phase systems (with or without neutral wire) and the harmonic analysis of voltages and currents.
- ✓ **conduct a direct Energy measurement** (without memorizing).
- ✓ **memorize** (pressing SAVE key) the sampled values of the Parameters present at the instrument's input generates a "Smp" record inside the instrument's memory. **It will be possible to analyze the memorized data ONLY by transferring it to a PC.**
- ✓ **record simultaneously** (pressing the START key after a proper setting): RMS values of voltages, currents, corresponding harmonics, active, reactive and apparent powers, power factors and  $\cos\phi$ , active, reactive and apparent energies, voltage sag and surge with 10ms resolution. **It will be possible to analyze the recorded data ONLY by transferring them to a PC.**

### CAUTION



Please note the difference between **memorize** and **record**. These terms will be used repeatedly in this manual. Please focus on their definitions and distinctions.

### 2.3. INITIAL SCREEN

When turning on the instrument by pressing ON/OFF, this screen will appear for a few seconds:

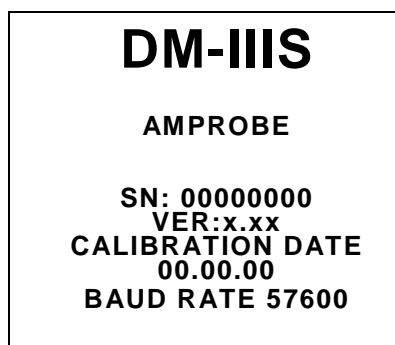

Here you can see:

- ✓ serial number of the instrument (SN.:
- ✓ firmware software release (VER.:
- ✓ calibration date (CALIBRATION:)
- ✓ transmission speed through serial I/O (Baud Rate)

### 3. PREPARING THE INSTRUMENT

#### 3.1. INITIAL CHECK

This instrument has been checked before shipment from an electrical and mechanical point of view. All possible precautions have been taken in order to deliver it in perfect condition. Notwithstanding, on receipt of the instrument we suggest that you check it summarily to make sure that no damage has occurred in transit. Should you find irregularities please contact the carrier immediately. Furthermore, please make sure that the parcel contains all the accessories and parts listed in paragraph 13.3. In case of discrepancies please contact your dealer. Should it be necessary to return the instrument to the supplier please keep to the instructions given at paragraph 17.

#### 3.2. INSTRUMENT POWER SUPPLY

The instrument can be powered by:

- ✓ 6 batteries 1.5V AA - LR6 series located in the compartment on the back of the instrument
- ✓ an external power supply code DMT-EXTPS supplied with the instrument (standard accessory).



#### CAUTION

For recordings ALWAYS use the external power supply (even though the instrument allows the operator to perform a recording using internal batteries).

The instrument uses sophisticated algorithms to prolong the battery life. Particularly:

- ✓ The instrument switches OFF the backlight Automatically after 5 seconds.
- ✓ If the instrument is displaying in real time (and the external power supply is not connected), after about 5 minutes from the last key pressure or switch rotation the instrument turns off automatically ("AUTOPOWER OFF" procedure).
- ✓ If the instrument is recording or is measuring energy (and the external power supply is not connected), after about 5 minutes from the last key pressure or switch rotation the instrument starts a special procedure to save the batteries ("ECONOMY MODE"): the instrument keeps recording but the display is turned off.

#### 3.3. CALIBRATION

The instrument complies with the standards mentioned in this manual. Its performance is guaranteed for one year from the purchase date.

#### 3.4. STORAGE

To guarantee accurate measurements, after a long storage period in severe environmental conditions wait until the instrument resumes its normal conditions (see environmental conditions listed in paragraph 13.2).



## 4. HOW TO OPERATE

### 4.1. INSTRUMENT: DESCRIPTION

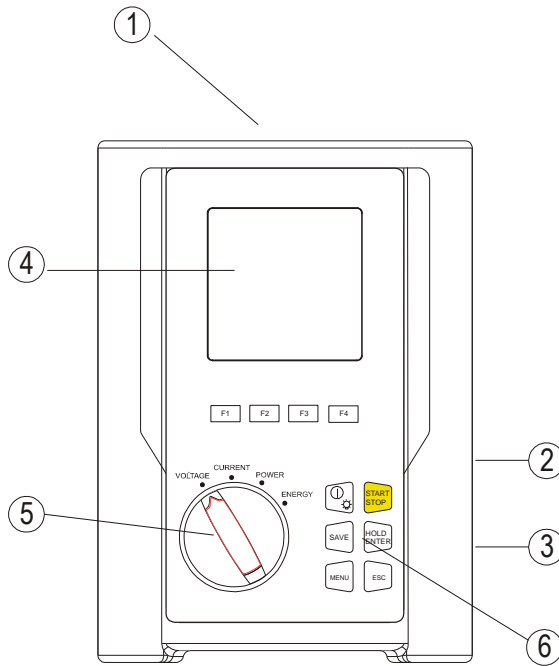

**Legend:**

1. Inputs for voltage and currents
2. RS232 serial output
3. Plug for external power supply
4. Display
5. Rotary switch
6. Keyboard

### 4.2. KEYBOARD: DESCRIPTION

The following keys are available.

- ☞ **ON/OFF:** turning on – turning off / Backlight ON (automatic Off after 5 sec.)
- ☞ **F1, F2, F3, F4:** multifunction keys. The various functions are deducible from the symbols shown on the bottom of the display.
- ☞ **MENU:** by pressing **MENU** it's possible to check and modify the recording parameters.
- ☞ **ESC:** to leave a menu or a sub-menu.
- ☞ **ENTER/HOLD:** double function key:
  - ✓ **ENTER:** to confirm the settings made
  - ✓ **HOLD:** to block the value updating in real time in all the screens. This function is disabled when recording or measuring energy. When this function is enabled it's not possible to record or take an energy measurement.
- ☞ **SAVE:** to save in the instrument memory a Record of "Smp" type (see paragraph 5.4) containing the instantaneous values of voltage and current present on the instrument inputs. This function is disabled during a recording.
- ☞ **START/STOP:** to start/stop manually a recording (see chapter 7).

**4.3. DISPLAY: DESCRIPTION**

The display is a graphic module with a resolution of 128x128 pixels (16384 pixels overall). Each pixel has a dimension of 0.5mm x 0.5mm, the visible area is a square of 73mm x 73mm.

The first line of the display shows date and time. If not correct, you can set the exact ones according to the procedure described at paragraph 5.1.2.

On the top right corner of the display you can always see the battery indicator and, if the external power supply is connected, the corresponding symbol.

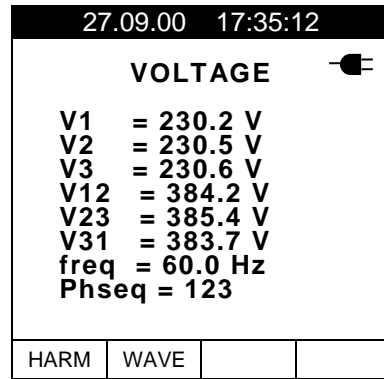
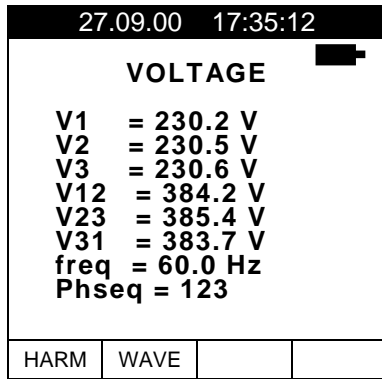

These symbols will be omitted in the following illustrations.

**4.4. BACKLIGHT FUNCTION**

When instrument is turned on, pressing briefly the **ON** button, the backlight will be enabled. The light will be automatically turned off after 5 seconds.

If the batteries are too low the instrument will disable automatically the backlight function.

## 5. MENU GENERAL

By pressing the **MENU** key the following screen will be displayed:

MENU GENERAL			
ANALYZER MEMORY RESET			
ANALYZER CONFIG RECORDER CONFIG			
CONTRAST DATE&TIME LANGUAGE			
↓	↑		

It's not possible to enter the **MENU** during a recording or a Real Time Energy measurement.

### 5.1. INITIAL SETTINGS

#### 5.1.1. How to adjust the contrast

By pressing the multifunction keys **F1** and **F2**, position the cursor on the **CONTRAST** item and confirm it by pressing the **ENTER** key.

By pressing the multifunction keys **F3** and **F4**, adjust the contrast (higher values correspond to a higher contrast while lower values correspond to a lower contrast) and press the **ENTER** key to SAVE the change or press **ESC** to quit the modification. This setting will remain unchanged after turning off the instrument.

#### 5.1.2. How to set date and time

By pressing the multifunction keys **F1** and **F2**, position the cursor on the **DATE&TIME** item and confirm it by pressing the **ENTER** key.

By pressing the multifunction keys **F1** and **F2** position the cursor on the Date format (**FORMAT**) and pressing the **F3** or **F4** keys select one of the following Date format:

**DD.MM.YY** (2 digit for day, 2 digit for Month, 2 digit for Year)

or

**MM.DD.YY** (2 digit for Month, 2 digit for Day, 2 digit for Year)

Then using **F1** and **F2** multifunction keys position the cursor on the value to be modified and change the value using **F3** and **F4** keys.

The time is expressed as **hh:mm** (2 digit for hours, 2 digit for minutes) military time.

Press the **ENTER** key to SAVE the change or press **ESC** to quit the modification.

This setting will remain unchanged also after turning off the instrument.

#### 5.1.3. How to set the language

By pressing the multifunction keys **F1** and **F2**, position the cursor on the **LANGUAGE** (EN) or **LINGUA** (IT) item and confirm it by pressing the **ENTER** key.

By pressing the multifunction keys **F1** and **F2**, position the cursor on the desired language and press the **ENTER** key to SAVE the change or press **ESC** to quit the modification.

This setting will remain unchanged after turning off the instrument.

## 5.2. BASIC SETTING: ANALYZER CONFIG

Selecting the **ANALYZER CONFIG** item and pressing the **ENTER** Key, the following page will be displayed:

ANALYZER CONFIG			
SYSTEM : <b>3PH4W</b>			
FREQUENCY: 60HZ			
CURRENT RANGE: 1000A			
CLAMP TYPE: FlexINT			
TV RATIO: 0001			
PASSWORD: ON			
↓	↑	+	-

This page of settings can be confirmed by pressing the **ENTER** key or cancelled by pressing the **ESC** key.

### 5.2.1. How to set the type of electrical system under test

This parameter permits you to select the type of electrical system under test among the following configurations:

- ✓ **SINGLE:** single phase system
- ✓ **3PH3W:** 3 wires system (three-phase system without neutral) (see paragraph 16.3.2)
- ✓ **3PH4W:** 4 wires system (three-phase system with neutral)

The connections to the instrument inputs will have to be in keeping with the type of system selected.

Position the cursor on the corresponding word by pressing the multifunction keys **F1** and **F2** and set the desired value by pressing the multifunction keys **F3** and **F4**.

### 5.2.2. How to set the fundamental frequency

Position the cursor on the corresponding word by pressing the multifunction keys **F1** and **F2** and select the network frequency between the possible values **50Hz** and **60Hz** by pressing the multifunction keys **F3** and **F4**. This parameter is important ONLY if the input voltage is not sufficient to recognize the value of the frequency (for example, only the clamps for the current measurement are connected). In this case the instrument generates an internal synchronism equal to the value of the set frequency.

### 5.2.3. How to set the current range

The value of this parameter **must be always equal to the full scale of the current clamps** used to take the measurement. In case multi-scale clamps are used, the value of this parameter must be equal to the scale selected on the clamps. Only for FLEX3 clamps You can set this parameter to 1000A or 3000A without any adjusting in the clamps. The instrument automatically will change its sensitivity according with settings. Set the desired value by pressing the multifunction keys **F3** and **F4**.

#### 5.2.4. How to set the clamp type

The value of this parameter **must always be equal to the clamp type you are using.**

Two types of clamps are available:

- ✓ STD: for Standard clamps or Current Transformer
- ✓ FlexEXT: for Flexible clamps with external power supply
- ✓ FlexINT: for Flexible clamps FLEX3 (coil directly connected with instrument's inputs). These clamps allows 1000A and 3000A range.

Set the desired value by pressing the multifunction keys **F3** and **F4**.

#### 5.2.5. How to set the value of the transformer voltage ratio (TV RATIO)

The instrument can also be interfaced with step-down transformers in the equipment under test: it can display the value of the voltages present on the primary winding of these transformers. To do this it will be necessary to set the value of the transformers' windings ratio from 2:1 to 3000:1. The default is set at 1:1 for measurements of non-transformer systems.

Select "TV RATIO" in the ANALYZER CONFIG menu. Set the desired value by pressing the multifunction keys **F3** and **F4**.

#### 5.2.6. How to enable/disable the password

The instrument is provided with a protective routine to avoid the risk of being disturbed or interrupted during a recording or an energy measurement. Once a recording or a direct energy measurement has been started (with the option "PASSWORD" enabled), after about 3 minutes from the last key pressure or switch rotation it won't be possible to press START/STOP to stop the recording, "PASSWORD" will be displayed and it will be necessary to insert the password.

In order to insert the password (which is not changeable), press the multifunction keys in the following sequence (within 10 seconds):

**F1, F4, F3, F2**

If you wait more than about 10 seconds the display will return to the meter mode and the instrument will continue recording. If you insert a wrong password the message "Password error" will be displayed under "PASSWORD". After a few seconds the display will return to meter mode and the instrument will continue recording. In order to enable/disable this option the correct password will have to be entered. The display will return to meter mode and START/STOP will have to be pressed again to stop the recording. You will then need to re-enter the "ANALYZER CONFIG" menu and scroll up or down to the item "PASSWORD: ON" using the multifunction keys **F1** and **F2**. Then turn the password off by pressing the multifunction keys **F3** and **F4**.

### 5.3. BASIC SETTING: RECORDER CONFIG

This option allows you to check and eventually modify the recording parameters and the selected parameters (up to a maximum of 64). The calculation of the selected values is not affected by the rotary switch position. If the number of selected values exceeds 64 the message "too many param" will be displayed. The MENU mode is divided into 4 separate sub-pages:

- ✓ 1<sup>st</sup> page: This page allows you to set the START/ STOP mode (AUTO or MANUAL), the START and STOP time if AUTO mode is selected, the Integration Period value, the Enabling/Disabling of voltage Sag and Surge detection, the Enabling/Disabling of Harmonics detection. Press **ENTER** to confirm the settings and pass to the following page. Press **ESC** to leave the Menu without modifying the existing parameters.
- ✓ 2<sup>nd</sup> page: This page is devoted to the settings relevant to the **VOLTAGE** recording. Press **ENTER** to confirm the settings and pass to the following page. Press **ESC** to leave this page without modifying the existing parameters. From this page you can enter the sub-page "Harmonics" which permits you to select the voltage harmonics to be recorded. Press **ENTER** to confirm the settings and leave the "Menu Harmonics". Press **ESC** to leave the "Menu Harmonics" without modifying the existing parameters.
- ✓ 3<sup>rd</sup> page: This page is devoted to the settings relevant to the **CURRENT** recording. Press **ENTER** to confirm the settings and pass to the following page. Press **ESC** to leave this page without modifying the existing parameters. From this page you can enter the sub-page "Harmonics" which permits you to select the current harmonics to be recorded. Press **ENTER** to confirm the settings and leave the "Menu Harmonics". Press **ESC** to leave the "Menu Harmonics" without modifying the existing parameters.
- ✓ 4<sup>th</sup> page: Menu composed of two sub-pages devoted to the selection of the **POWERS and ENERGIES** to be recorded. From this page you can enter the sub-page "POWER" and "ENERGY" which permits you to select the parameters to be recorded. Selecting the active powers for the recording, the corresponding active energies will be automatically selected. Selecting the reactive powers for the recording, the corresponding reactive energies will be selected. Press **ENTER** to leave this page confirming the modifications made. Press **ESC** to leave the "Menu" without modifying the existing parameters.

The various pages of the "RECORDER CONFIG" can be schematized as follows:

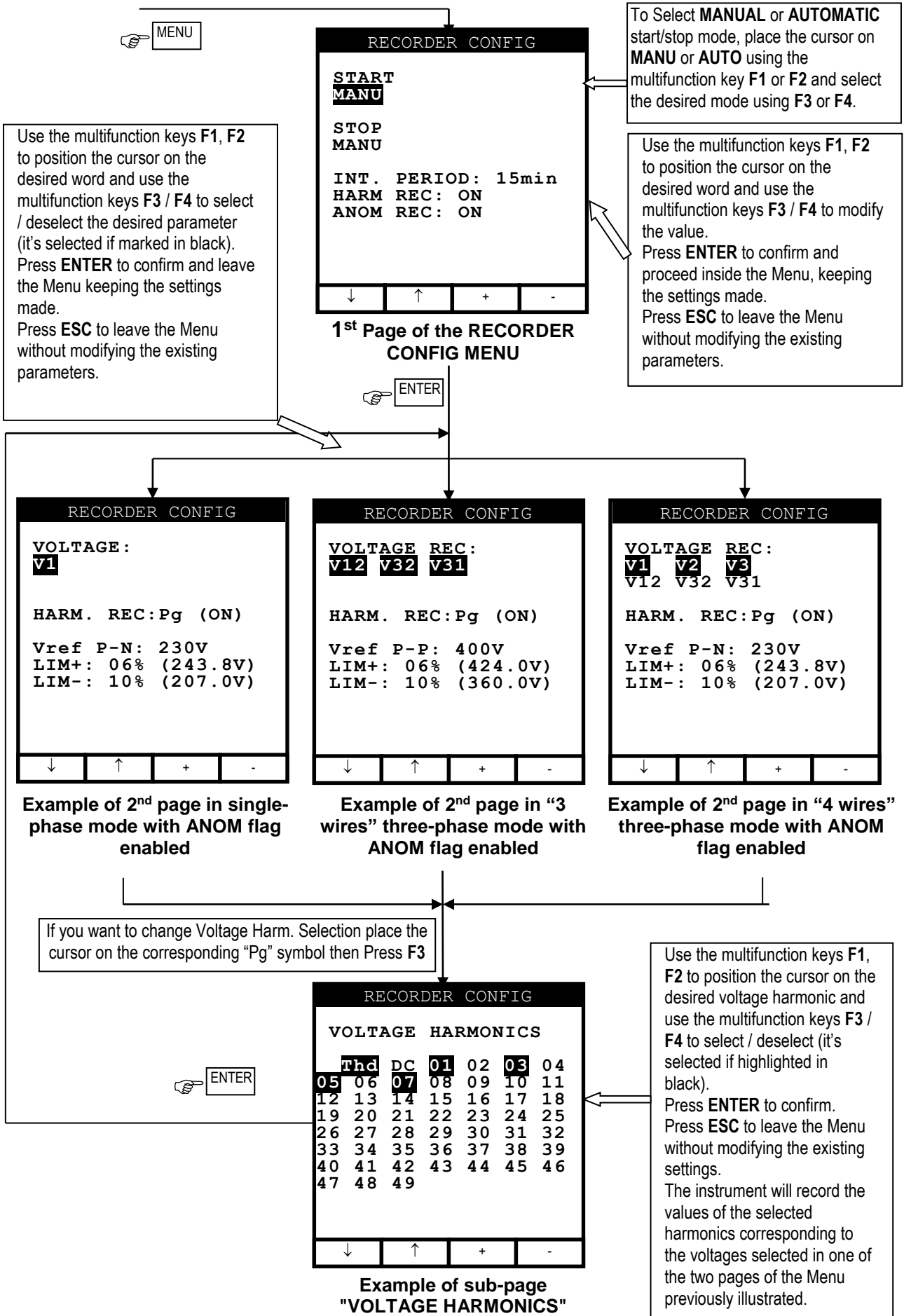

Use the multifunction keys **F1**, **F2** to position the cursor on the desired word and use the multifunction keys **F3** / **F4** to modify the value or select / deselect the desired parameter (it's selected if marked in black). Press **ENTER** to confirm. Press **ESC** to leave the Menu without modifying the existing settings.

From 2<sup>nd</sup> page of RECORDER CONFIG MENU

ENTER

RECORDER CONFIG

CURRENT REC:  
**I1**

HARM. REC: Pg (ON)

↓ ↑ + -

Example of 3<sup>rd</sup> page in single-phase mode

RECORDER CONFIG

CURRENT REC:  
**I1 I2 I3**

HARM. REC: Pg (ON)

↓ ↑ + -

Example of 3<sup>rd</sup> page in "3 wires" three-phase mode

RECORDER CONFIG

CURRENT REC:  
**I1 I2 I3 IN**

HARM. REC: Pg (ON)

↓ ↑ + -

Example of 3<sup>rd</sup> page in "4 wires" three-phase mode

If you want to change Current Harm. Selection place Cursor on the corresponding "Pg" symbol then Press **F3**

ENTER

RECORDER CONFIG

CURRENT HARMONICS

	Thd	DC	01	02	03	04
05	06	<b>07</b>	08	09	10	11
12	13	14	15	16	17	18
19	20	21	22	23	24	25
26	27	28	29	30	31	32
33	34	35	36	37	38	39
40	41	42	43	44	45	46
47	48	49				

↓ ↑ + -

Example of sub-page "CURRENT HARMONICS"

Use the multifunction keys **F1**, **F2** to position the cursor on the desired current harmonic and use the multifunction keys **F3** / **F4** to select / deselect (it's selected if marked in black). Press **ENTER** to confirm. Press **ESC** to leave the Menu without modifying the existing settings. The instrument will record the values of the selected harmonics corresponding to the currents selected in one of the two pages of the Menu previously illustrated.



From 3<sup>rd</sup> page  
of RECORDER CONFIG MENU

ENTER

```

RECORDER CONFIG
CO-GENERATION : ON
POWER : Pg
ENERGY : Pg
    
```

Example of 4<sup>th</sup> page

In order to select the POWER to be recorded use the multifunction keys F1, F2 to position the cursor on the corresponding "Pg" Symbol and then press F3

ENTER

```

RECORDER CONFIG
P1    Q1i  Q1c  S1
Pf1   dPf1
    
```

Example of POWER sub-page in single-phase mode

```

RECORDER CONFIG
Pt    P12  P32
Qti   Q12i Q32i
Qtc   Q12c Q32c
St    S12  S32
Pft   dPft
    
```

Example of POWER sub-page in "3 wires" three-phase mode

```

RECORDER CONFIG
Pt    P1    P2    P3
Qti   Q1i  Q2i  Q3i
Qtc   Q1c  Q2c  Q3c
St    S1    S2    S3
Pfi   Pf1  Pf2  Pf3
dPfi  dPf1 dPf2 dPf3
    
```

Example of POWER sub-page in "4 wires" three-phase mode

Selecting the active powers for the recording, the corresponding active energies will be automatically selected.

Selecting the reactive powers for the recording, the corresponding reactive energies will be selected.

From 3<sup>rd</sup> page  
of RECORDER CONFIG MENU

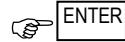

```

RECORDER CONFIG
CO-GENERATION : ON
POWER : Pg
ENERGY : Pg
    
```

Example of 4<sup>th</sup> page

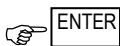

In order to select the ENERGIES to be recorded use the multifunction keys F1, F2 to position the cursor on the corresponding "Pg" Symbol and then press F3

```

RECORDER CONFIG
Ea1  Eri1  Erc1  Es1
    
```

Example of ENERGY sub-page in single-phase mode

```

RECORDER CONFIG
Ea1  Eri1  Erc1  Es1
Ea2  Eri2  Erc2  Es2
    
```

Example of ENERGY sub-page in "3 wires" three-phase mode

```

RECORDER CONFIG
Ea1  Eri1  Erc1  Es1
Ea2  Eri2  Erc2  Es2
Ea3  Eri3  Erc3  Es3
    
```

Example of ENERGY sub-page in "4 wires" three-phase mode

Selecting/deselecting the active energies for the recording, the corresponding active powers will be automatically selected/deselected.

Selecting/deselecting the reactive energies for the recording, the corresponding reactive powers will be selected/deselected.

Selecting/deselecting the reactive energies for the recording, the corresponding reactive powers will be selected/deselected.

Symbols	Description	Advised settings
START:MAN	The recording of all the selected parameters will start at 00 seconds after pressing <b>START/STOP</b> (see chapter 7).	☺
STOP:MAN	The recording of all the selected parameters will be interrupted manually by pressing <b>START/STOP</b> (see chapter 9).	☺
START:AUTO STOP:AUTO	The recording of all the selected values will be started / interrupted at the set dates and times. In order to start the recording the user will have to press START/STOP to set the instrument in Stand-by mode until the start date and time previously set (see chapter 7).	
INT. PERIOD	The value of this parameter determines how many seconds the values of <b>all the selected parameters</b> will be memorized (see chapter 16.4.1). Available choices: 5sec, 10sec, 30sec, 1min, 2min 5min, 10min, 15min, 60min.	<b>15min</b> ☺
HARM REC.	<b>ON</b> = the instrument will record the values of the selected <b>voltage and current harmonics</b> corresponding to the voltages and currents selected in the corresponding pages "Voltage" and "Current". Example: If the following Parameters are selected: <b>a) Phase Voltage 1 and 2, Thd, Harmonics 1,3,5.</b> <b>b) Phase Current 2 and 3, Thd, Harmonics 3,5,7.</b> The instrument will record: <b>a) The Phase Voltage 1 and 2, Thd and Harmonics 1,3,5 of the Phase Voltage 1 and 2 while it will not record anything about Phase Voltage 3</b> <b>b) The Phase Current 2 and 3, Thd and Harmonics 3,5,7 of the Phase Current 2 and 3 while it will not record nothing about Phase Current 1</b>	☺
	<b>OFF</b> = the instrument <b>will not record</b> any voltage or current harmonic selected	
ANOM REC.	<b>ON</b> = the Instrument will record Voltage Sag and Surge (see paragraph 16.1)	☺
	<b>OFF</b> = the instrument <b>will not record</b> any voltage Sag and Surge	
V1, V2, V3 V12, V23 or V32, V31	RMS value of the voltage of phase 1, phase 2, phase 3 respectively, values of the phase-to-phase voltages 1-2, 2-3 or 3-2 and 3-1.	☺ Single phase: <b>V1</b> 3 wires <b>V<sub>12</sub> V<sub>32</sub> V<sub>31</sub></b> 4 wires <b>V<sub>1</sub>, V<sub>2</sub>, V<sub>3</sub></b>
Thd, DC, 01...49	Voltage Total Harmonic Distortion, DC Component, 01..49 Harmonics respectively	☺ <b>Thd,01,03,05,07</b>
Vref (only if ANOM. REC flag has been set ON)	RMS reference value for Voltage used in Voltage Anomalies detection (Voltage Sag and Surge). The Reference is: a) Voltage Phase to Neutral for Single Phase and 4 wires three phase system b) Voltage Phase to Phase for 3 wires three phase system	☺ Single phase: <b>230V</b> 3 wires: <b>400V</b> 4 wires <b>230V</b>
LIM+, LIM- (only if ANOM. REC flag has been set ON)	High and Low Voltage Percent threshold used in Voltage Anomalies detection (Voltage Sag and Surge). Example: Three Phase System 4 wires. Vref = 120, LIM+= 6%, LIM-=10% => High Lim = 127.2V, Low Lim = 108.0V The Instrument will detect a voltage Anomalies if the RMS Voltage Values (calculated every 10ms) beyond the above calculated thresholds (see paragraph 16.1).	☺ Single phase: <b>120V</b> 3 wires: <b>480V</b> 4 wires <b>277V</b>
I1, I2, I3, IN	RMS value of the current of phase 1, phase 2, phase 3 and of the neutral respectively.	☺ Single phase: <b>I1</b> 3 wires: <b>I1, I2, I3</b> 4 wires <b>I1, I2, I3, IN</b>
Thd, DC, 01..49	Current Total Harmonic Distortion, DC Component, 01..49 Harmonics respectively	☺ <b>Thd,01,03,05,07</b>

CO-GENERATION	<b>ON</b> = the instrument is able to face situations of CO-GENERATION of electrical equipment (that is, the equipment under test is able to generate energy besides absorbing it). Accordingly, the instrument will record the powers and energies both absorbed and generated (see paragraph 16.3.1). <b>If this flag is enabled the maximum number of parameters which can be selected decrease to 38.</b>	
	<b>OFF</b> = the instrument will record ONLY the powers and energies absorbed.	☺
Pt, P1, P2, P3, P12, P32	Values of the active power (total, of phase1, phase2 and phase3) (only for 3 wires measurement) value of the power measured by the Wattmeter 1-2 and 3-2 respectively	☺ Single phase: <b>P1</b> 3 wires: <b>Pt</b> 4 wires <b>Pt, P1, P2, P3</b>
Qti, Q1i, Q2i, Q3i, Q12i, Q32i	Values of the inductive reactive power (total, of phase 1, phase 2, phase 3) (only for 3 wires measurement) value of the reactive inductive power measured by the VAR meters 1-2 and 3-2 respectively	☺ Single phase: <b>Q1i Q1c</b> 3 wires: <b>Qti Qtc</b> 4 wires <b>Qti Q1i Q2i, Q3i</b> <b>Qtc Q1c Q2c, Q3c</b>
Qtc, Q1c, Q2c, Q3c, Q12c, Q32c	Values of the capacitive reactive power (total, of phase 1, phase 2, phase 3) (only for 3 wires measurement) value of the reactive capacitive power measured by the VA meters 1-2 and 3-2 respectively	
St, S1, S2, S3, S12, S32	Values of the apparent power (total, of phase1, phase2, phase3) (only for 3 wires measurement) value of the power measured by the VA meters 1-2 and 3-2 respectively	☺ Single phase: <b>S1</b> 3 wires: <b>St</b> 4 wires <b>St, S1, S2, S3</b>
Pft, Pf1, Pf2, Pf3	Values of the power factors (total, of phase 1, phase 2 and phase 3 respectively)	☺ Single phase: <b>Pf1 dPf1</b> 3w: <b>Pft dPft</b> 4w: <b>Pft Pf1 Pf2 Pf3 dPft dPf1 dPf2 dPf3</b>
dpft, dpf1, dpf2, dpf3	Values of the $\cos\varphi$ (total, of phase 1, phase 2 and phase 3 respectively)	
Eat, Ea1, Ea2, Ea3	Values of the active energy (total, of phase1, phase2 and phase3)	☺ Single phase: <b>Ea1</b> 3 wires: <b>Eat</b> 4 wires <b>Eat Ea1 Ea2 Ea3</b>
Erit, Eri1, Eri2, Eri3	Values of the inductive reactive energy (total, of phase 1, phase 2 and phase 3)	☺ Single phase: <b>Eri1 Erc1</b> 3 wires: <b>Erit Erct</b> 4 wires <b>Erit Eri1 Eri2 Eri3 Erct Erc1 Erc2 Erc3</b>
Erct, Erc1, Erc2, Erc3	Values of the capacitive reactive energy (total, of phase 1, phase 2, phase 3)	
Est, Es1, Es2, Es3	Values of the Apparent Energy (total, of phase1, phase2 and phase3)	☺ Single phase: <b>Es1</b> 3 wires: <b>Est</b> 4 wires <b>Est Es1 Es2 Es3</b>

**The value of the network frequency is automatically selected if at least one phase voltage (for the single-phase mode or the 4 wires three phase mode) or at least one phase-to-phase voltage (for the 3 wires three phase mode) is selected.**

The symbols "i" and "c" stand for reactive powers (Q), power factors (Pf) and  $\cos\varphi$  (dpf) inductive and capacitive respectively.

Selecting a power factor (Pf) or a  $\cos\varphi$  (dPf) for the recording automatically their inductive value and their capacitive value will be recorded separately.

For eventual messages displayed see appendix 1 – MESSAGES DISPLAYED.

**5.4. ANALYZER MEMORY**

This option permits you to display:

- ✓ The present content of the instrument memory
- ✓ The size of the memorized data
- ✓ The residual space available for future recordings (expressed in days and hours)

**All the stored data can be displayed only if downloaded to a PC with the operating software.**

After selecting “ANALYZER MEMORY” from the Main Menu the screen below will be displayed

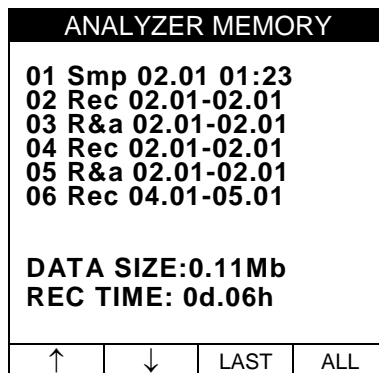

**Example of ANALYZER MEMORY screen**

- ✓ Rec: **recordings** effected with respective Start and Stop dates expressed in the format “day.month” (start) – “day.month” (stop) **without** Voltage Sag and Surge detection.
- ✓ R&a: **recordings** effected with respective Start and Stop dates expressed in the format “day.month” (start) – “day.month” (stop) **with** Voltage Sag and Surge detection.
- ✓ Smp: values of the **samples** of voltage and current stored by pressing SAVE.
- ✓ DATA SIZE: dimensions of the data saved in the instrument memory.
- ✓ REC TIME: amount of memory available, calculated on the basis of the parameters selected for recording, therefore the most complete one (expressed in the format “days.hours”) to make recordings.

The maximum quantity of Rec + R&a + Smp which can be contained by the instrument is **35**.

Following keys are enabled:

- ☞ **F1, F2:** (only if the quantity of Rec+R&a+Smp is higher than 7) to run over all the recordings stored in the instrument memory.
- ☞ **F3:** to cancel the last recording effected.
- ☞ **F4:** to cancel all the recordings effected.

## 5.5. RESET

This option re-establishes the default settings of the instrument.

The default settings of the instrument consist of:

### ✓ ANALYZER CONFIG:

Frequency:	60Hz
Full scale of the clamps:	1000A
Transforming ratio of voltmetric transformers:	1
Type of electrical equipment:	4 wires
Password:	enabled

### ✓ RECORDER CONFIG:

Start:	Manual (the recording is started at 00 sec mark on clock after pressing the START/STOP key)
Stop:	Manual
Integration period:	15min
Recording of harmonics:	ON
Recording of Sag and Surge:	ON
Voltage Reference for Sag and Surge detection:	230V
Upper Limit for Sag and Surge detection:	6%
Lower Limit for Sag and Surge detection:	10%
Selected voltages:	V1, V2, V3
Selected voltage harmonics:	Thd, 01, 03, 05, 07
Selected currents:	I1, I2, I3, IN
Selected current harmonics:	Thd, 01, 03, 05, 07
CO-GENERATION:	OFF
Powers, Pf and $\cos\varphi$ selected:	Pt, P1, P2, P3 Qti, Q1i, Q2i, Q3i Qtc, Q1c, Q2c, Q3c St, S1, S2, S3 Pft, Pf1, Pf2, Pf3 dpft, dpf1, dpf2, dpf3
Energies:	Eat, Ea1, Ea2, Ea3 Erit, Eri1, Eri2, Eri3 Erct, Erc1, Erc2, Erc3 Est, Es1, Es2, Es3

The RESET command will not erase the instrument's memory.

## 6. SWITCH FUNCTIONS

For a simple usage, the main functions of the instrument can be selected by rotating the switch:

- ☞ Position "**VOLTAGE**": to be used to display **voltage and corresponding harmonics** (see paragraph 6.1)
- ☞ Position "**CURRENT**": to be used to display **current and corresponding harmonics** (see paragraph 6.2)
- ☞ Position "**POWER**": it permits you to display **all the parameters measurable by the instrument**: voltage, current, active, reactive and apparent power, power factor,  $\cos\phi$  and energy (see paragraph 6.3)
- ☞ Position "**ENERGY**": to be used to display **active, reactive and apparent power, power factor,  $\cos\phi$  and energy** (see paragraph 6.4)

More practically, we may schematize the right procedure of use as follows:

1. Check and eventually modify the basic settings of the instrument
2. By rotating the switch, select the type of measurement to be taken
3. Connect the instrument to the electrical system to be tested
4. Evaluate the values of the parameters under test
5. If you want to record:
  - a) Decide what to record
  - b) Press **MENU** and check if the existing parameters meet your requirements
6. Connect the External Power Supply
7. Start the recording by pressing **START/STOP**.

## 6.1. POSITION "VOLTAGE"

This function permits you to display in real time the RMS value of AC/DC voltage, the peak and Thd value of the 3 phase voltages (see paragraph 16.2), the waveform and the harmonic spectrum of the 3 phase voltages.

### 6.1.1. Symbols

The VOLTAGE position has three working modes:

- ✓ METER
- ✓ WAVE
- ✓ HARM

These modes will be described in detail in the next paragraphs.

The symbols used are described below:

Symbol	Description
V1, V2, V3	RMS value of the voltage of phase 1, phase 2, phase 3 respectively
V12, V23 or V32, V31	RMS Value of the phase to phase voltages
Vpk1, Vpk2, Vpk3, Vpk12, Vpk32	Peak value of the voltage of phase 1, phase 2, phase 3 and of the phase to phase voltage 12 and 32 respectively
h01 - h49	Harmonic 01 - Harmonic 49.
ThdV	Factor of total harmonic distortion of the voltage (see paragraph 16.2).
freq	Network frequency
Phseq	Phase sequence indicator "123" → correct "132" → inverted "023" → null voltage on the black wire "103" → null voltage on the red wire "120" → null voltage on the blue wire "100" → null voltages on the red and blue wires "020" → null voltages on the black and blue wires "003" → null voltages on the black and red wires

Tab. 1: Symbols used in the position VOLTAGE



### 6.1.2. "METER" mode

On rotating the switch to this position the instrument selects automatically the METER mode corresponding to one of the below screens according to the settings made as per paragraph 5.2.

27.09.00 17:35:12			
<b>SINGLE PHASE VOLTAGE</b>			
V1 = 230.2 V			
Vpk1 = 325.5 V			
ThdV = 0.0 %			
freq = 60.0 Hz			
HARM.	WAVE		

Example of screen in single-phase mode

27.09.00 17:35:12			
<b>VOLTAGE</b>			
V12 = 384.2 V			
V32 = 385.4 V			
V31 = 383.7 V			
freq = 60.0 Hz			
HARM.	WAVE		

Example of screen in "3 wires" three-phase mode

27.09.00 17:35:12			
<b>VOLTAGE</b>			
V1 = 230.2 V			
V2 = 230.5 V			
V3 = 230.6 V			
V12 = 384.2 V			
V23 = 385.4 V			
V31 = 383.7 V			
freq = 60.0 Hz			
Phseq = 123			
HARM.	WAVE		

Example of screen in "4 wires" three-phase mode

The symbols used are described in Tab. 1. For eventual messages displayed see Appendix 1 – MESSAGES DISPLAYED. Following keys are enabled:

- ☞ **F1:** to pass to "HARMONIC" mode (see paragraph 6.1.3).
- ☞ **F2:** to pass to "WAVE" mode (see paragraph 6.1.4).
- ☞ **SAVE:** to save in the instrument memory a record of "Smp" type (see paragraph 5.4) containing the instantaneous values of voltage and current present on the instrument inputs. This function is disabled during a recording.
- ☞ **ENTER/HOLD:** to enable/disable the HOLD function (updating interruption) of the displayed data. All the previous functions remain available. When the HOLD function is enabled, the word **HOLD** is displayed. When this function is enabled it's not possible to record or take an energy measurement. This function is disabled during a recording or an energy measurement.
- ☞ **MENU:** to enter in the **MENU** mode and change the instrument settings (see paragraph 5.2 and 5.3). It's not possible to enter the configuration MENU during a recording or an energy measurement.
- ☞ **START/STOP:** to record **selected parameters** according to the instrument's settings (see chapter 7).

### 6.1.3. "HARM" mode

Selecting the HARM mode one of the below screens will be displayed according to the settings made as per paragraph 5.2. The screens show the harmonics (see paragraph 16.2) of the phase or phase-to-phase voltage.

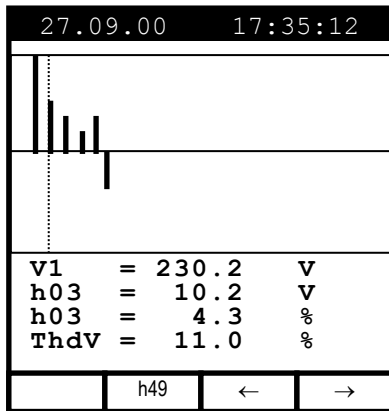

Example of screen in single-phase system

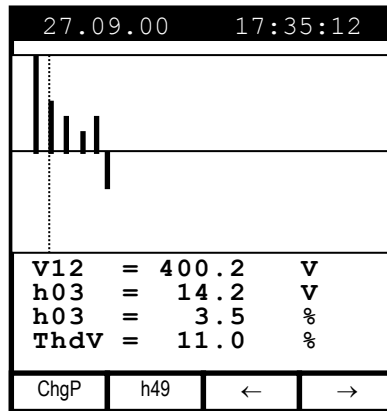

Example of screen in "3 wires" three-phase system

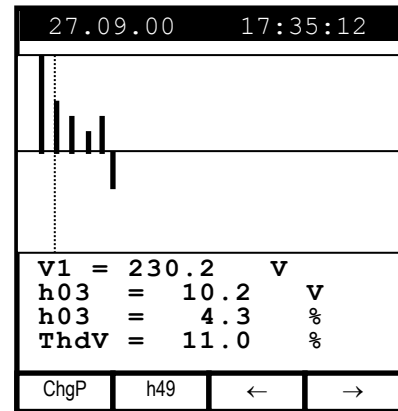

Example of screen in "4 wires" three-phase system

The symbols used are described in Tab. 1. For eventual messages displayed see Appendix 1 – MESSAGES DISPLAYED. The displayed histograms represent the harmonic content of the voltage under test. The value of the first harmonic h01 (fundamental at 60Hz) is not represented in scale along with the other harmonics in order to maximize the display of the latter. In case both voltage and current are connected to the instrument inputs, eventual negative values of the harmonics (therefore represented under the horizontal axis), indicate that such voltage harmonics are "generated" by the load.

Following keys are enabled:

- ☞ **F3, F4:** to move the cursor of the selected harmonic leftwards and rightwards respectively. At the same time the values relevant to the order no. of the selected harmonic and to the corresponding absolute and relative values (calculated on the basis of the fundamental) are updated.
- ☞ **F1** (only for three-phase mode): to display the values of the harmonics of the other voltages available. The voltage displayed is indicated above the F3 key.
- ☞ **F2:** to display the page of the harmonics h01 ÷ h24 (symbol **h24**) or that of the harmonics h25 ÷ h49 (symbol **h49**).
- ☞ **ESC:** to return back to METER mode (see paragraph 6.1.2).
- ☞ **SAVE:** to save in the instrument memory a "Smp" type record (see paragraph 5.4) and the instantaneous values of voltage and current present on the instrument inputs. This function is disabled during a recording.
- ☞ **ENTER/HOLD:** to enable/disable the HOLD function (updating interruption) of the displayed data. All the previous functions remain however available. When the HOLD function is enabled, the word **HOLD** is displayed. When this function is enabled it's not possible to record or take an energy measurement. This function is disabled during a recording or an energy measurement.
- ☞ **MENU:** to enter in the **MENU** mode and change the instrument settings (see paragraph 5.2 and 5.3). It's not possible to enter the configuration MENU during a recording or an energy measurement.
- ☞ **START/STOP:** to record **selected parameters** according to the instrument's settings (see chapter 7).

**6.1.4. "WAVE" mode**

Selecting the WAVE mode one of the below screens will be displayed according to the settings made as per paragraph 5.2. The screens show the waveform of the phase or phase-to-phase voltage.

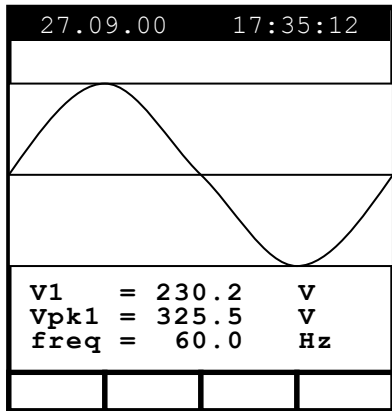

Example of screen in single-phase system

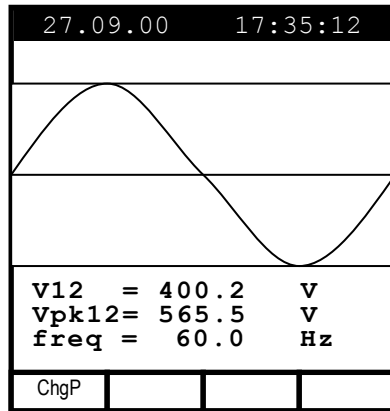

Example of screen in "3 wires" three-phase system

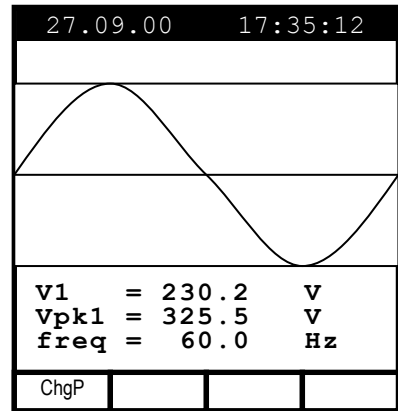

Example of screen in "4 wires" three-phase system

The symbols used are described in Tab. 1.

For eventual messages displayed see Appendix 1 – MESSAGES DISPLAYED.

Following keys are enabled:

- ☞ **F1:** (only for three-phase mode): to display the values corresponding to the following phase.
- ☞ **ESC:** to return back to METER mode (see paragraph 6.1.2).
- ☞ **SAVE:** to save in the instrument memory a record of "Smp" type (see paragraph 5.4) containing the instantaneous values of voltage and current present on the instrument inputs. This function is disabled during a recording.
- ☞ **ENTER/HOLD:** to enable/disable the HOLD function (updating interruption) of the displayed data. All the previous functions remain available. When the HOLD function is enabled, the word **HOLD** is displayed. When this function is enabled it's not possible to record or take an energy measurement. This function is disabled during a recording or an energy measurement.
- ☞ **MENU:** to enter in the **MENU** mode and change the instrument settings (see paragraph 5.2 and 5.3). It's not possible to enter the configuration MENU during a recording or an energy measurement.
- ☞ **START/STOP:** to record **selected parameters** according to the instrument's settings (see chapter 7).

## 6.2. POSITION "CURRENT"

This function permits you to display in real time the RMS value of AC/DC currents, the peak and Thdl value (see paragraph 16.2) of the 3 phase currents, the waveform and the harmonic spectrum of the 3 phase currents.

### 6.2.1. Symbols

The CURRENT position has three working modes:

- ✓ METER
- ✓ WAVE
- ✓ HARM

These modes will be described in detail in the next paragraphs.

The symbols used are described below:

Symbol	Description
I1, I2, I3	RMS value of the current of phase 1, phase 2, phase 3 respectively
IN	RMS value of the current on the neutral
Ipk1, Ipk2, Ipk3	Peak value of the current of phase 1, phase 2, phase 3 respectively
h01 ÷ h49	Harmonic 01 ÷ harmonic 49.
Thdl	Total harmonic distortion factor of the current (see paragraph 16.2).
freq	Network frequency

Tab. 2: Symbols used in the position CURRENT

### 6.2.2. "METER" mode

On rotating the switch to this position the instrument selects automatically the METER mode corresponding to one of the screens below according to the settings made as per paragraph 5.2.

27.09.00 17:35:12			
<b>SINGLE PHASE CURRENT</b>			
I1 = 30.21 A			
Ipk1 = 49.53 A			
ThdI = 23.06 %			
freq = 60.0 Hz			
HARM.	WAVE		

Example of screen in single-phase mode

27.09.00 17:35:12			
<b>CURRENT</b>			
I1 = 30.21 A			
I2 = 23.53 A			
I3 = 23.06 A			
freq = 60.0 Hz			
HARM.	WAVE		

Example of screen in "3 wires" three-phase mode

27.09.00 17:35:12			
<b>CURRENT</b>			
I1 = 30.21 A			
I2 = 23.53 A			
I3 = 23.06 A			
IN = 8.4 A			
freq = 60.0 Hz			
HARM.	WAVE		

Example of screen in "4 wires" three-phase mode

The symbols used are described in Tab. 2.

For eventual messages displayed see Appendix 1 – MESSAGES DISPLAYED.

Following keys are enabled:

- ☞ **F1:** to pass to "HARMONIC" mode (see paragraph 6.2.3).
- ☞ **F2:** to pass to "WAVE" mode (see paragraph 6.2.4).
- ☞ **SAVE:** to save in the instrument memory a record of "Smp" type (see paragraph 5.4) containing the instantaneous values of voltage and current present on the instrument inputs. This function is disabled during a recording.
- ☞ **ENTER/HOLD:** to enable/disable the HOLD function (updating interruption) of the displayed data. All the previous functions remain however available. When the HOLD function is enabled, the word **HOLD** is displayed. When this function is enabled it's not possible to record or take an energy measurement. This function is disabled during a recording or an energy measurement.
- ☞ **MENU:** to enter in the **MENU** mode and change the instrument settings (see paragraph 5.2 and 5.3). It's not possible to enter the configuration MENU during a recording or an energy measurement.
- ☞ **START/STOP:** to record **selected parameters** according to the instrument's settings (see chapter 7).

### 6.2.3. "HARM" mode

Selecting the HARM mode one of the screens below will be displayed according to the settings made as per paragraph 5.2. The screens show the harmonics (see paragraph 16.2) of the phase currents.

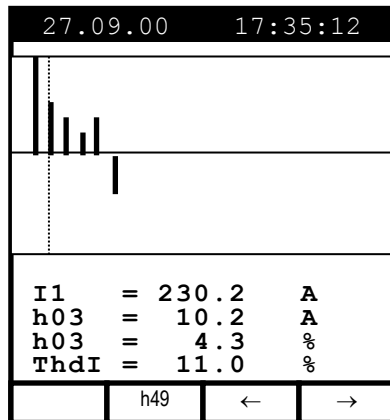

Example of screen in single-phase mode

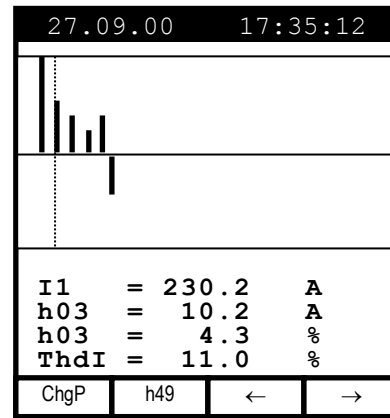

Example of screen in "3 wires" or "4 wires" three-phase mode

The symbols used are described in Tab. 2. For eventual messages displayed see Appendix 1 – MESSAGES DISPLAYED. The displayed histograms represent the harmonic content of the current under test. The value of the first harmonic h01 (primary at 60Hz) is not represented in scale along with the other harmonics in order to maximize the display of the latter. In case both voltage and current are connected to the instrument inputs, eventual negative values (therefore represented under the horizontal axis) indicate that such current harmonics are "generated" by the load. Following keys are enabled:

- ☞ **F3, F4:** to move the cursor of the selected harmonic leftwards and rightwards respectively. At the same time the values relevant to the order no. of the selected harmonic and to the corresponding absolute and relative values (calculated on the basis of the fundamental) are updated.
- ☞ **F1** (only for three-phase mode): to display the values of the harmonics of the other voltages available. The voltage displayed is indicated above the F3 key.
- ☞ **F2:** to display the page of the harmonics h01 ÷ h24 (**h24** symbol) or that of the harmonics h25 ÷ h49 (**h49** symbol).
- ☞ **ESC:** to return back to METER mode (see paragraph 6.2.2)
- ☞ **SAVE:** to store in the instrument memory a record of "Smp" type (see paragraph 5.4) and the instantaneous values of voltage and current present on the instrument inputs. This function is disabled during a recording.
- ☞ **ENTER/HOLD:** to enable/disable the HOLD function (updating interruption) of the displayed data. All the previous functions remain available. When the HOLD function is enabled, the word **HOLD** is displayed. When this function is enabled it's not possible to record or take an energy measurement. This function is disabled during a recording or an energy measurement.
- ☞ **MENU:** to enter in the **MENU** mode and change the instrument settings (see paragraph 5.2 and 5.3). It's not possible to enter the configuration MENU during a recording or an energy measurement.
- ☞ **START/STOP:** to record **selected parameters** according to the instrument's settings (see chapter 7).

#### 6.2.4. "WAVE" mode

Selecting the WAVE mode one of the below screens will be displayed according to the settings made as per paragraph 5.2. The screens show the waveform of the phase currents.

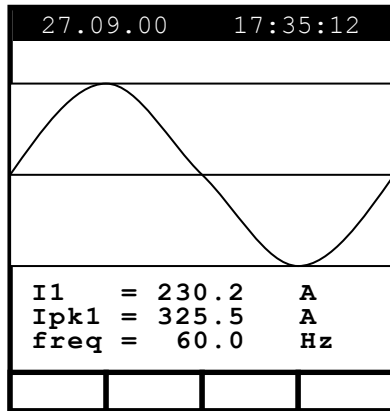

Example of screen in single-phase mode

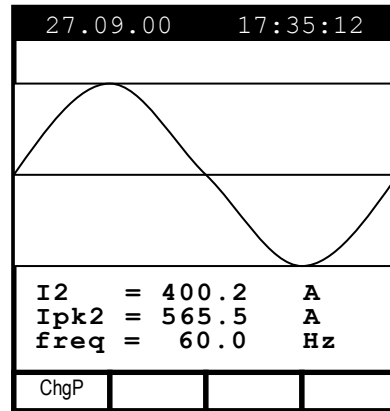

Example of screen in "3 wires" or "4 wires" three-phase mode

The symbols used are described in Tab. 2.

For eventual messages displayed see Appendix 1 – MESSAGES DISPLAYED.

Following keys are enabled:

- ☞ **F1:** (only for three-phase mode): to display the values relevant to the following phase.
- ☞ **ESC:** to return back to METER mode (see paragraph 6.2.2).
- ☞ **SAVE:** to save in the instrument memory a record of "Smp" type (see paragraph 5.4) containing the instantaneous values of voltage and current present on the instrument inputs. This function is disabled during a recording.
- ☞ **ENTER/HOLD:** to enable/disable the HOLD function (updating interruption) of the displayed data. All the previous functions remain available. When the HOLD function is enabled, the word **HOLD** is displayed. When this function is enabled it's not possible to record or take an energy measurement. This function is disabled during a recording or an energy measurement.
- ☞ **MENU:** to enter in the **MENU** mode and change the instrument settings (see paragraph 5.2 and 5.3). It's not possible to enter the configuration MENU during a recording or an energy measurement.
- ☞ **START/STOP:** to record **selected parameters** according to the instrument's settings (see chapter 7).

### 6.3. POSITION "POWER"

This function permits you to display in real time the RMS value of AC/DC voltage, the peak and ThdV value of the 3 phase voltages, the waveform of the 3 phase voltages, the RMS value of AC/DC currents, the peak and ThdI of the 3 phase currents, the waveform of the 3 phase currents. Furthermore, the instrument calculates and displays the value of the phase and total active powers, the value of the phase and total reactive and capacitive powers, the value of the phase and total power factors and  $\cos\varphi$ .

#### 6.3.1. Symbols

The position POWER has two working modes:

- ✓ METER
- ✓ WAVE

For voltage and current harmonics see paragraphs 6.1.3 and 6.2.3 respectively.

These modes will be described in detail in the next paragraphs.

The symbols used are described below:

Symbol	Description
V1, V2, V3	RMS value of the voltage of phase 1, phase 2, phase 3 respectively
V12, V23, V32, V31	RMS Value of the phase to phase voltages
freq	Network frequency
Phseq	Phase sequence indicator "123" → correct "132" → inverted "023" → null voltage on the black wire "103" → null voltage on the red wire "120" → null voltage on the blue wire "100" → null voltages on the red and blue wires "020" → null voltages on the black and blue wires "003" → null voltages on the black and red wires
I1, I2, I3	RMS value of the current of phase 1, phase 2, phase 3 respectively
IN	RMS value of the current of the neutral
Pt, P1, P2, P3	Values of the active power (total, of phase 1, phase 2, phase 3 respectively)
P12, P32	(only for 3 wires measurement) Value of the power measured by the Wattmeter 1-2 and 3-2 respectively (see paragraph 16.3.2).
Qt, Q1, Q2, Q3	Values of the reactive power (total, of phase 1, phase 2, phase 3 respectively)
Q12, Q32	(only for 3 wires measurement) Value of the power measured by the VAR meter Va1-2 and 3-2 respectively (see paragraph 16.3.2).
St, S1, S2, S3	Values of the apparent power (total, of phase 1, phase 2, phase 3 respectively)
S12, S32	(only for 3 wires measurement) Value of the power measured by the VA meter Va1-2 and 3-2 respectively (see paragraph 16.3.2).
Pft, pf1, pf2, pf3	Values of the power factors (total, of phase 1, phase 2, phase 3 respectively)
dPft, dpf1, dpf2, dpf3	Value of the $\cos\varphi$ (total, of phase 1, phase 2, phase 3 respectively)
Ead, Pd	Values of the Total Active Energy and Active Power On demand respectively
Esd, Sd	Values of the Total Apparent Energy and Apparent Power On demand respectively

Tab. 3: Symbols used in the position POWER

The symbols "i" and "c" stand for reactive powers (Q), power factors (Pf) and  $\cos\varphi$  (dpf) respectively inductive and capacitive.



### 6.3.2. "METER" mode

Upon rotating the switch to this position the instrument selects automatically the METER mode corresponding to one of the below screens according to the settings made as per paragraph 5.2.

27.09.00 17:35:12			
<b>SINGLE PHASE POWER</b>			
V1 = 230.0 V			
I1 = 145.3 A			
P1 = 32.91 kW			
Q1 = 5.767 kVAR			
S1 = 33.41 kVA			
pf1 = 0.99 i			
dpf1 = 0.99 i			
WAVE			

Example of screen in single-phase mode

27.09.00 17:35:12			
<b>POWER THREE WIRE</b>			
Pt = 64.19 kW			
Qt = 10.99 kVAR			
St = 65.12 kVA			
pft = 0.99 i			
dpft = 1.00 i			
ChgP		WAVE	

Example of screen in "3 wires" three-phase mode

27.09.00 17:35:12			
<b>POWER THREE PHASE</b>			
Pt = 135.8 kW			
Qt = 24.59 kVAR			
St = 138.0 kVA			
pft = 0.98 i			
dpft = 1.00 i			
Phseq= 123			
ChgP		WAVE	

Example of screen in "4 wires" three-phase mode

The symbols used are described in Tab. 3.

For eventual messages displayed see Appendix 1 – MESSAGES DISPLAYED.

Following keys are enabled:

- ☞ **F2:** to pass to "WAVE" mode (see paragraph 6.3.3).
- ☞ **F1:** (only for three-phase measurement) to display the previous or the following screen. On the basis of the settings made as per paragraph 5.2 following screens are displayed cyclically:
  - ✓ Three-phase 3 wires: total three-phase values, Wattmeter phases 1-2 and 2-3 values, Peak Demand
  - ✓ Three-phase 4 wires: total three-phase values, phase1, phase2 and phase3 values, Peak Demand
- ☞ **SAVE:** to save in the instrument memory a record of "Smp" type (see paragraph 5.4) and the instantaneous values of voltage and current present on the instrument inputs. This function is disabled during a recording.
- ☞ **ENTER/HOLD:** to enable/disable the HOLD function (updating interruption) of the displayed data. All the previous functions remain however available. When the HOLD function is enabled, the word **HOLD** is displayed. When this function is enabled it's not possible to record or take an energy measurement. This function is disabled during a recording or an energy measurement.
- ☞ **MENU:** to enter in the **MENU** mode and change the instrument settings (see paragraph 5.2 and 5.3). It's not possible to enter the configuration MENU during a recording or an energy measurement.
- ☞ **START/STOP:** to record **selected parameters** according to the instrument's settings (see chapter 7).

### 6.3.2.1. PEAK ENERGY DEMAND

In three-phase system selecting the POWER Position and pressing **F1** key 3 times you can reach the “Peak Demand” mode.

The “**Peak Demand**” screen shows the Max Average value of Active Power (and the corresponding Energy) or Max Average value of Apparent Power (and the corresponding Energy) measured during the last (or running) recording. The Average value is evaluated in the Integration Period set for the recording. This screen also shows the corresponding Active Energy and the corresponding Peak Date and Time.

27.09.00 17:35:12			
<b>PEAK DEMAND THREE PHASE</b>			
Ead = 98.36 kWh Pd = 24.59 kW			
Peak Date 25.09.00 17:00 Int Period: 15min Rec n: 06			
ChgP		Wh	VAh

27.09.00 17:35:12			
<b>PEAK DEMAND THREE PHASE</b>			
Esd = 120.84 kVAh Sd = 30.21 kVA			
Peak Date 25.09.00 18:15 Int Period: 15min Rec n: 06			
ChgP		Wh	VAh

Example of “PEAK ENERGY DEMAND” screen

- ☞ **F1:** to display the previous or the following screen. On the basis of the settings made as per paragraph 5.2 following screens are displayed cyclically:
  - ✓ Three-phase 3 wires: total three-phase values, Wattmeter phases 1-2 and 2-3 values, Peak Demand
  - ✓ Three-phase 4 wires: total three-phase values, phase1, phase2 and phase3 values, Peak Demand
- ☞ **F3:** to show Active Power and Active Energy values
- ☞ **F4:** to show Apparent Power and Apparent Energy values
- ☞ **SAVE:** to save in the instrument memory a record of “Smp” type (see paragraph 5.4) and the instantaneous values of voltage and current present on the instrument inputs. This function is disabled during a recording.
- ☞ **ENTER/HOLD:** to enable/disable the HOLD function (updating interruption) of the displayed data. All the previous functions remain however available. When the HOLD function is enabled, the word **HOLD** is displayed. When this function is enabled it's not possible to record or take an energy measurement. This function is disabled during a recording or an energy measurement.
- ☞ **MENU:** to enter in the **MENU** mode and change the instrument settings (see paragraph 5.2 and 5.3). It's not possible to enter the configuration MENU during a recording or an energy measurement.
- ☞ **START/STOP:** to record **selected parameters** according to the instrument's settings (see chapter 7).

### 6.3.3. "WAVE" mode

Selecting the WAVE mode one of the below screens will be displayed according to the settings made as per paragraph 5.2. The screens show the waveform of the phase currents and the phase (or phase-to-phase) voltage.

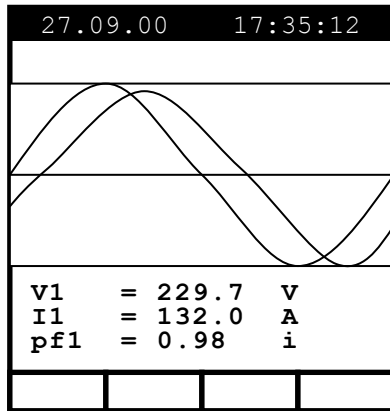

Example of screen in single-phase mode

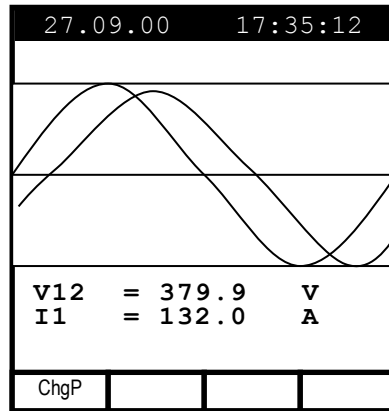

Example of screen in "3 wires" three-phase mode

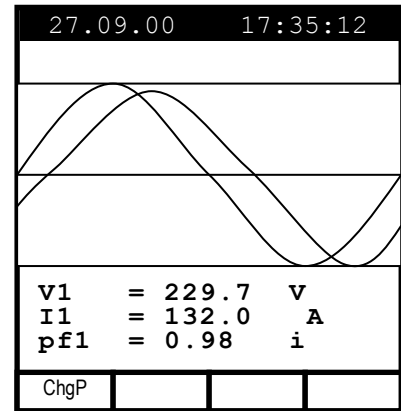

Example of screen in "4 wires" three-phase mode

The symbols used are described in Tab. 3.

For eventual messages displayed see Appendix 1 – MESSAGES DISPLAYED.

Following keys are enabled:

- ☞ **F1:** (only for three-phase mode): to display the values relevant to the following phase. On the basis of the settings made as per paragraph 5.2 following screens are displayed cyclically:
  - ✓ 3 wires three-phase: values of the Wattmeter 1-2, values of the wattmeter 2-3
  - ✓ 4 wires three-phase: values of phase 1, phase 2 and phase 3
- ☞ **ESC:** to return back to METER mode (see paragraph 6.3.2).
- ☞ **SAVE:** to save in the instrument memory a record of "Smp" type (see paragraph 5.4) containing the instantaneous values of voltage and current present on the instrument inputs. This function is disabled during a recording.
- ☞ **ENTER/HOLD:** to enable/disable the HOLD function (updating interruption) of the displayed data. All the previous functions remain however available. When the HOLD function is enabled, the word **HOLD** is displayed. When this function is enabled it's not possible to record or take an energy measurement. This function is disabled during a recording or an energy measurement.
- ☞ **MENU:** to enter in the **MENU** mode and change the instrument settings (see paragraph 5.2 and 5.3). It's not possible to enter the configuration MENU during a recording or an energy measurement.
- ☞ **START/STOP:** to record **selected parameters** according to the instrument's settings (see chapter 7).

## 6.4. POSITION "ENERGY"

This function permits to display the values of the phase and total active powers, the value of the phase and total capacitive and inductive reactive powers, the values of the power factors and phase and total  $\cos\phi$ . Furthermore, the instrument is able to measure directly (see 6.4.2) the values of the phase and total active energies and the values of the phase and total capacitive and inductive reactive energies.

### 6.4.1. Symbols

The position ENERGY has only one working mode:

- ✓ METER

This mode will be described in detail in the next paragraphs.

The symbols used are described below:

Symbol	Description
Pt, P1, P2, P3	Values of the total active power, of phase 1, phase 2, phase 3 respectively
P12, P32	(only for 3 wires measurement) Value of the power measured by the Wattmeter 1-2 and 3-2 respectively (see paragraph 16.3.2)
Qt, Q1, Q2, Q3	Values of the total reactive power, of phase 1, phase 2, phase 3 respectively
Q12, Q32	(only for 3 wires measurement) Value of the power measured by the VARmeter 1-2 and 3-2 respectively (see paragraph 16.3.2)
St, S1, S2, S3	Values of the total apparent power, of phase 1, phase 2, phase 3 respectively
S12, S32	(only for 3 wires measurement) Value of the power measured by the VAmeter 1-2 and 3-2 respectively (see paragraph 16.3.2)
Eat, Ea1, Ea2, Ea3	Values of the total active energy, of phase 1, phase 2, phase 3 respectively
Erit, Eri1, Eri2, Eri3	Values of the total inductive reactive Energy, of phase 1, phase 2, phase 3 respectively
Erct, Erc1, Erc2, Erc3	Values of the total capacitive reactive Energy, of phase 1, phase 2, phase 3 respectively
Est, Es1, Es2, Es3	Values of the total Apparent Energy, of phase 1, phase 2, phase 3 respectively

Tab. 4: Symbols used in the position ENERGY

The symbols "i" and "c" stand for reactive powers (Q) and energies (Er) inductive and capacitive respectively.

### 6.4.2. "METER" mode

On rotating the switch to this position the instrument selects automatically the METER mode corresponding to one of the below screens according to the settings made as per paragraph 5.2.

27.09.00 17:35:12	
<b>ENERGY SINGLE PHASE</b>	
Ea1 = 0.000 kWh	
Erc1 = 0.000 kVARh	
Eri1 = 0.000 kVARh	
Es1 = 0.000 kVAh	
P1 = 36.38 kW	
Q1 = 6.375 kVAR	
S1 = 36.94 kVA	
Meas Time: 00:00:00	
Meas	

Example of screen in single-phase mode

27.09.00 17:35:12	
<b>ENERGY THREE PHASE</b>	
Eat = 0.000 kWh	
Erct = 0.000 kVARh	
Erit = 0.000 kVARh	
Est = 0.000 kVAh	
Pt = 36.38 kW	
Qt = 6.375 kVAR	
St = 36.94 kVA	
Meas Time: 00:00:00	
Meas	

Example of screen in "3 wires" three-phase mode

27.09.00 17:35:12	
<b>ENERGY THREE PHASE</b>	
Eat = 0.000 kWh	
Erct = 0.000 kVARh	
Erit = 0.000 kVARh	
Est = 0.000 kVAh	
Pt = 167.7 kW	
Qt = 30.47 kVAR	
St = 170.4 kVA	
Meas Time: 00:00:00	
ChgP	Meas

Example of screen in "4 wires" three-phase mode

The symbols used are described in Tab. 4.

For eventual messages displayed see Appendix 1 – MESSAGES DISPLAYED.

Following keys are enabled:

- ☞ **F2:** to start / stop immediately a **direct energy measurement**. The energy counters will start increasing proportionally to the active power absorbed by the load.  
**The results obtained cannot be memorized.**  
**If the active power is negative the counters will not increase.**
- ☞ **F1:** (only for 4 wires measurement) to display the following screen. On the basis of the settings made as per paragraph 5.2 following screens are displayed cyclically:

Overall three-phase values, values of phase 1, phase 2 and phase 3

- ☞ **SAVE:** to save in the instrument memory a record of "Smp" type (see paragraph 5.4) containing the instantaneous values of voltage and current present on the instrument inputs. This function is disabled during a recording.
- ☞ **ENTER/HOLD:** to enable/disable the HOLD function (updating interruption) of the displayed data. All the previous functions remain however available. When the HOLD function is enabled, the word **HOLD** is displayed. When this function is enabled it's not possible to record or take an energy measurement. This function is disabled during a recording or an energy measurement.
- ☞ **MENU:** to enter in the **MENU** mode and change the instrument settings (see paragraph 5.2 and 5.3). It's not possible to enter the configuration MENU during a recording or an energy measurement.
- ☞ **START/STOP:** to record **selected parameters** according to the instrument's settings (see chapter 7).

## 7. STARTING A RECORDING

As you can read in the paragraph 5.3 a recording can be started manually or automatically. Therefore, after setting all the parameters **and leaving the Menu**, the instrument will start to record:

- ✓ MANUALLY: the recording will start when Instrument's time reaches the "00" seconds value after pressing START/STOP.
- ✓ AUTOMATICALLY: **If the operator has pressed START/STOP** the instrument will remain in stand-by until the date and time previously set, then the recording will start. While **if the operator doesn't press START/STOP the recording will never start.**

### CAUTION



For recordings **ALWAYS use the external power supply** even the instrument allows the operator to perform a recording using internal batteries.

If you press Start a recording without the external power supply the instrument will display a warning message "**No ext supply**". Press **START** key again to run the recording or press **ESC** to quit.

If during a recording the external power supply is de-energized, the instrument will continue the recording using the internal battery power until the batteries are exhausted (the data stored until the definitive turning off won't get lost). For this we recommend you **ALWAYS insert a new set of batteries before a long recording.**

The instrument uses sophisticated algorithms to prolong the battery life. Particularly:

- ✓ The instrument switches OFF the backlight Automatically after 5 seconds.
- ✓ If the instrument is just displaying in real time (and the external power supply is not connected), after about 5 minutes from the last key pressure or switch rotation the instrument turns off automatically ("AUTOPOWER OFF" function).
- ✓ If the instrument is recording or is measuring energy (and the external power supply is not connected), after about 5 minutes from the last key pressure or switch rotation the instrument starts a special procedure to save the batteries ("ECONOMY MODE"): the instrument keeps recording but the display is turned off.

Before starting a recording the operator should first evaluate the state of the equipment, decide what to record and set the instrument accordingly.

In order to facilitate this task we have decided to supply the instrument pre-set with a general configuration, which should fit most cases.

The chosen configuration is the following

✓ ANALYZER CONFIG:

Frequency:	60Hz
Full scale of the clamps:	1000A
Transforming ratio of voltmetric transformers:	1
Type of electrical equipment:	4 wires
Password:	enabled

✓ RECORDER CONFIG:

Start:	Manual (the recording is started 1 minute after pressing the START/STOP key)
Stop:	Manual
Integration period:	15min
Recording of harmonics:	ON
Recording of Sag and Surge:	ON
Voltage Reference for Sag and Surge detection:	230V
Upper Limit for Sag and Surge detection:	6%
Lower Limit for Sag and Surge detection:	10%
Selected voltages:	V1, V2, V3
Selected voltage harmonics:	Thd, 01, 03, 05, 07
Selected currents:	I1, I2, I3, IN
Selected current harmonics:	Thd, 01, 03, 05, 07
CO-GENERATION:	OFF
Powers, Pf and $\cos\phi$ selected:	Pt, P1, P2, P3 Qti, Q1i, Q2i, Q3i Qtc, Q1c, Q2c, Q3c St, S1, S2, S3 Pft, Pf1, Pf2, Pf3 dpft, dpf1, dpf2, dpf3 Eat, Ea1, Ea2, Ea3 Erit, Eri1, Eri2, Eri3 Erct, Erc1, Erc2, Erc3 Est, Es1, Es2, Es3
Energies:	

If the user changed the instrument's settings can quickly resume the above configuration using the RESET option (see paragraph 5.5).

By pressing **START/STOP** the recording of the selected parameters is started according to the settings made in the MENU (see paragraphs 5.2 and 5.3). The rotary switch position doesn't affect the recording setting.

As the default value of the integration periods is set at 15 minutes the instrument will store data in the temporary memory for 15 minutes. Afterwards the instrument will elaborate the results saved in the temporary memory and will save the first series of values in the definitive memory. Therefore, if an integration period of 15 minutes has been set, the recording will continue for about 15 minutes before producing a series of recorded values. If the recording is interrupted before the selected integration period has completely elapsed the data stored in the temporary memory will not be elaborated and the corresponding series of values won't be transferred to the definitive memory.

## 8. DURING A RECORDING

If during a recording the external power supply is de-energized, the instrument will continue the recording using the internal battery power until the batteries are exhausted (the data stored up to the point the instrument shuts down won't get lost). For this we recommend you **ALWAYS insert a new set of batteries before a long recording.**

The instrument uses sophisticated algorithms to prolong the battery life. Particularly if the instrument is recording or is measuring energy (and the external power supply is not connected), after about 5 minutes from the last key pressure or switch rotation the instrument starts a special procedure to save the batteries ("ECONOMY MODE"): the instrument keeps recording but the display is turned off.

During a recording the following are disabled:

- ✓ **AUTOPOWER OFF function**
- ✓ **ON/OFF key**
- ✓ **HOLD key**
- ✓ **SAVE key**

Press the **MENU** key and the following screen will appear:

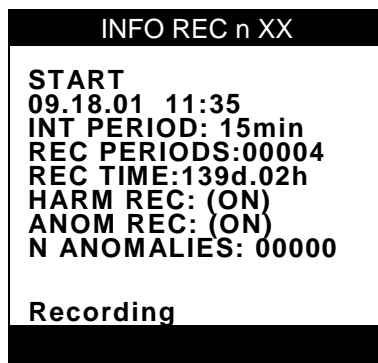

```
INFO REC n XX
START
09.18.01 11:35
INT PERIOD: 15min
REC PERIODS:00004
REC TIME:139d.02h
HARM REC: (ON)
ANOM REC: (ON)
N ANOMALIES: 00000
Recording
```

This page includes:

1. START Date and Time
2. Integration Period
3. Actual Number of Elapsed Integration Periods
4. Actual Recording Time
5. Status of Harmonic Flag
6. Status of Voltage Anomalies Flag
7. Number of Voltage anomalies occurred during the recording



## 9. STOPPING A RECORDING OR AN ENERGY MEASUREMENT

The instrument uses a protective routine to avoid the risk of being disturbed or interrupted during a recording or an energy measurement. Once a recording or a direct energy measurement (see paragraph 6.4.2) has been started (with the option PASSWORD enabled), after about 3 minutes from the last key pressure or switch rotation it won't be sufficient to press START/STOP (if a recording is running) or **F2** (if an energy measuring is running) to stop the recording, it will be necessary to insert the password.

In order to insert the password (which is not changeable), press the multifunction keys in the following sequence (within 10 seconds):

**F1, F4, F3, F2**

In order to enable/disable this option see paragraph 5.2.

If a wrong password is inserted, the instrument will display an error message and will repeat the request.

If no key is pressed after about 10 seconds the instrument returns back to the original screen.

## **10. CONNECTING THE INSTRUMENT TO A PC**

In order to connect the instrument to a PC you must connect the serial cable shipped with the instrument to the serial output.

**NOTE: Any standard RS-232 cable will not work with the DM-IIIIS.**

The available transmission speeds are the following: 9600, 19200, 57600 (default value)

The value of the transmission speed (Baud Rate) is displayed on the initial screen (immediately after turning on the instrument) (see paragraph 2.3). The value of this parameter can be modified only with the management software.

**For download instructions please refer to software help file.**

In order to transfer the memorized data from the instrument to the PC the following procedure must be followed:

- 1. Switch ON the instrument and wait until the Initial screen disappears.**
- 2. Connect the serial output of the instrument to the serial output of the PC through the serial cable.**
- 3. Install the software and start it – Close the introduction window.**
- 4. Refer to software help file for further instructions.**

## 11. MEASURING PROCEDURES

### 11.1. HINTS FOR FLEXIBLE CLAMPS USE

All flexible clamps are based on Rogowski's coil principle:

$$V_{coil} = -M \frac{di}{dt}$$

which shows that the voltage output signal is proportional to the rate of change of current. In order to get current value, the voltage output signal is integrated electronically. Typically the voltage output signal is really low and this suggests using shielded cable for coil connection to instrument's inputs.

#### **WARNING**



**As the Coil Output connector can't be perfectly shielded it's recommended to outdistance it by any Potential source.**

**11.2. USING THE INSTRUMENT IN A SINGLE PHASE SYSTEM**

**CAUTION**



The maximum voltage between L1 and COM inputs is 370V~ phase – earth. Do not measure voltages exceeding the limits prescribed by this manual. Should you exceed the voltage limits you could damage the instrument and/or its components or endanger your safety.

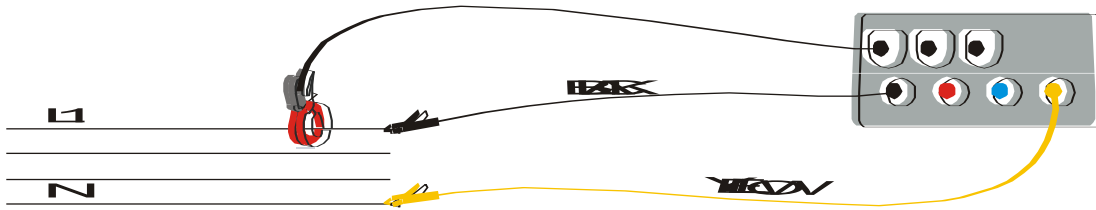

Fig. 1: Instrument connection in a single-phase system

**CAUTION**



If possible, before connecting the instrument to the electrical equipment to be tested take the power supply off the electrical equipment.

1. Check, and if needed modify, the basic settings of the instrument (see paragraphs 5.2 and 5.3). Particularly, the **single-phase** mode must be set.
2. Rotate the switch to the position corresponding to the type of analysis desired. In case of doubts, select the position **POWER** (see paragraph 6.3).
3. Connect the phase and neutral voltage wires respecting the connections shown in the picture.
4. If you want to measure current and power, connect the clamp meter to the phase conductor respecting the specifications shown on the clamp and the connections shown in the picture.  
In case of doubt, select the position **POWER** and check if the active power P is positive. If it is negative, remove current transducer from the wire and reconnect it so the transducer label faces the opposite direction.
5. Apply voltage to the electrical equipment under test (if previously shut off for the instrument connection).
6. The values of the available electrical parameters will be displayed on the display of the instrument. For further details, see the paragraph relevant to the position of the switch.
7. You can press **HOLD** to interrupt the updating in real time of the displayed values.
8. If you want to record:
  - a) Check, and if needed modify, the values of the basic parameters (see paragraphs 5.2 and 5.3).
  - b) Check, and if needed modify, the recording parameters by pressing **MENU** (see the paragraph corresponding to the position of the rotary switch selected).
  - c) To start the recording press **START** (see chapter 6).

**11.3. USING THE INSTRUMENT IN A THREE PHASE 4 WIRE SYSTEM**

**CAUTION**



The maximum voltage between L1, L2, L3 & COM inputs is CAT III 635 V~ phase – phase 370 V~ phase to earth. Do not measure voltages exceeding the limits prescribed by this manual. Should you exceed the voltage limits you could damage the instrument and/or its components or endanger your safety.

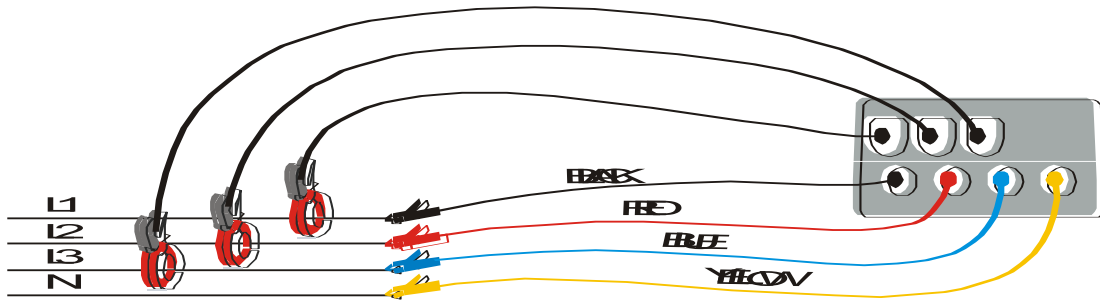

Fig. 2: Instrument connection in a three-phase 4 wire system

**CAUTION**



If possible, before connecting the instrument to the electrical equipment to be tested take the power supply off the electrical equipment.

1. Check, and if needed modify, the basic settings of the instrument (see paragraphs 5.2 and 5.3). Particularly, the **3PH4W** mode must be set.
2. Rotate the switch to the position corresponding to the type of analysis desired. In case of doubts, select the position **POWER** (see paragraph 6.3).
3. Connect the phase and neutral voltage wires following the connections shown in Fig. 2.
4. To measure current and power, connect the clamp meter to the phase conductor following the specifications shown on the clamp and the connections shown in Fig. 2. In case of doubts select the position **POWER** and, connecting one clamp a time, check if:
  - a) the phase sequence is correct (see paragraph 6.1.2).
  - b) the active power P of each phase is positive. If it is negative, remove current transducer from the wire and reconnect it so the transducer label faces the opposite direction.
  - c) the value of the Pf of each phase is not excessively low (typically it is not lower than 0.4). In case the Pf is lower than 0.4, check if the phase voltage is associated with the right clamp meter, (for example the voltage of phase 1 must be associated to the clamp meter no. 1).
5. Apply voltage to the electrical equipment under test (if previously shut off for the instrument connection).
6. The values of the available electrical parameters will be displayed. For further details see the paragraph relevant to the position of the switch.
7. You can press **HOLD** to interrupt the real time updating of the displayed values.
8. If you want to record:
  - a) Check and modify the values of the basic parameters (see paragraphs 5.2 and 5.3).
  - b) Check and, if needed, modify the recording parameters by pressing **MENU** (see the paragraph corresponding to the position of the rotary switch selected).
  - c) To start the recording press **START** (see chapter 6).

**11.4. USING THE INSTRUMENT IN A THREE PHASE 3 WIRE SYSTEM**

**CAUTION**



The maximum voltage between L1, L2, L3 and COM (L2) inputs is CATIII 635V~ phase-phase. Do not measure voltages exceeding the limits prescribed by this manual. Should you exceed the voltage limits you could damage the instrument and/or its components or endanger your safety.

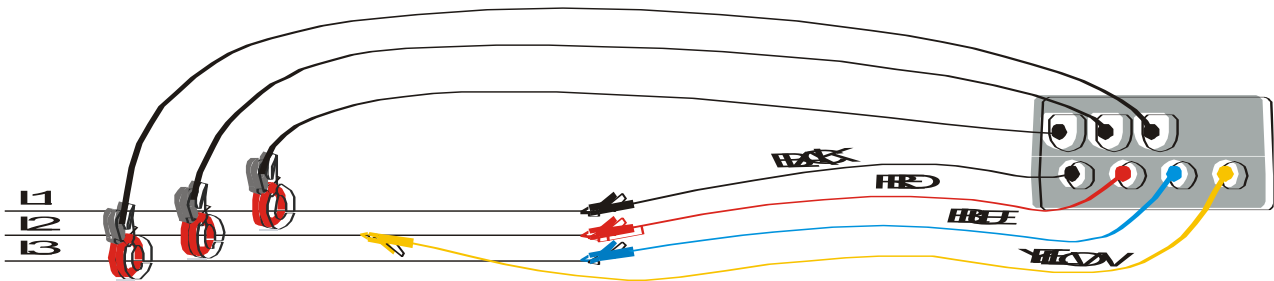

Fig. 3: Instrument connection in a 3 wire / three-phase system

**CAUTION**



- Please note that in this case the yellow cable (neutral) is connected with the red cable on phase 2.
- If possible, before connecting the instrument to the electrical equipment to be tested take the power supply off the electrical equipment.

1. Check, and if needed modify, the basic settings of the instrument (see paragraphs 5.2 and 5.3). Particularly, the **3-wire** mode must be set.
2. Rotate the switch to the position corresponding to the type of analysis desired. In case of doubts, select the position **POWER** (see paragraph 6.3).
3. Connect the phase and neutral voltage wires following the connections shown in Fig. .
4. To measure current and power, connect the clamp to the phase conductor following the specifications shown on the clamp and the connections shown in Fig. . In case of doubts set **temporarily** the **3PH3W** mode, select the **POWER** position, connect the yellow wire of the instrument to earth and, connecting one clamp a time, check if:
  - a) The phase sequence is correct (see paragraph 6.1.2).
  - b) The active power P of each phase is positive. If negative, turn the clamp of the phase in question.
  - c) The value of the Pf of each phase is excessively low (typically it is not lower than 0.4). If the Pf is lower than 0.4, check if the phase voltage is associated with the right clamp meter, (ex. the voltage of phase 1 must be associated to the clamp n. 1).
  - d) After checking, and if needed modifying, the connection of the instrument to the equipment re-set the **3-wire** mode and the connections shown in Fig. (yellow and red wires together).
5. Energize the electrical equipment under test.
6. The values of the available electrical parameters will be displayed of the instrument. For further details see the paragraph relevant to the position of the switch.
7. You can press **HOLD** to interrupt the updating in real time of the displayed values.
8. If you want to record:
  - a) Check and modify the values of the basic parameters (see paragraphs 5.2 and 5.3).
  - b) Check and eventually modify the recording parameters by pressing **MENU** (see the paragraph corresponding to the position of the rotary switch selected).

- c) To start the recording press **START** (see chapter 6).

## 12. MAINTENANCE

### 12.1. GENERAL

The DM-IIIS is a precision instrument. For its' use and storage, follow the recommendations and instructions contained in this manual in order to avoid possible damages or dangers.

Never use the instrument in environments with a high humidity or temperature.

Do not expose the instrument to direct sunlight.

Always turn off the instrument after use.

### 12.2. BATTERY REPLACEMENT

When the battery indicator on the display appears almost empty (  ) the batteries must be replaced.

#### CAUTION



Only qualified technicians should operate the instrument. Before replacing the batteries disconnect the test leads from circuit under voltage in order to avoid electrical shocks.

1. Disconnect cables and clamps from the circuit under test.
2. Turn the instrument off by pressing ON/OFF.
3. Remove the cables from the input terminals.
4. Unscrew the screw of the battery cover and remove the cover.
5. Replace the batteries with 6 new 1.5 V - AA.
6. Reposition the cover and fasten it with the proper screw.

### 12.3. CLEANING

Use a soft dry cloth to clean the instrument. Do not use wet clothes, solvents, water and so on.



## 13. TECHNICAL SPECIFICATIONS

### 13.1. FEATURES

The accuracy is stated as [% of the reading  $\pm$  number of digits]. It refers to the following atmospheric conditions: temperature 73°F  $\pm$  2°F (23°C  $\pm$  1°C) with relative humidity < 75%.

#### 13.1.1. Voltage measurement (auto-ranging)

Range	Accuracy	Resolution	Input impedance
15-370V	$\pm(0.5\%+2\text{digit})$	0.2V	300k $\Omega$ (phase-neutral)
310-635V		0.4V	600k $\Omega$ (phase-phase)

#### 13.1.2. Voltage anomalies detection (manual selection of range)

##### Voltage

Range	Accuracy	Resolution	Input impedance
15-370V	$\pm(0.5\%+2\text{digit})$	0.2V	300k $\Omega$ (phase-neutral)
30-635V		0.4V	600k $\Omega$ (phase-phase)

##### Time

Accuracy (ref. to 60Hz)	Resolution
$\pm 8.33\text{ms}$ ( $\frac{1}{2}$ period of fundamental)	8.33ms ( $\frac{1}{2}$ period of fundamental)

#### 13.1.3. Current measurement (using external transducer)

Range	Accuracy	Resolution	Input impedance	Protection against overloads
0.005-0.26V	$\pm(0.5\%+2\text{digit})$	0.0001V	100k $\Omega$ for STD or FlexEXT 8.3k $\Omega$ for FlexINT (1000A) 9.4k $\Omega$ for FlexINT (3000A)	5V
0.26-1V		0.0004V		

Minimal Current measurable is equal to 0.5% of Clamp Full Scale

#### 13.1.4. Power measurement (cos $\phi$ : 0.5c – 0.5i)

Value	Ranges	Accuracy	Resolution
Active power	0 – 999.9W	$\pm(1.0\%+2\text{digit})$	0.1W
	1KW – 999.9KW		0.1KW
	1MW – 999.9MW		0.1MW
Reactive power	0 – 999.9VAR		0.1VAR
	1KVAR – 999.9KVAR		0.1KVAR
	1MVAR – 999.9MVAR		0.1MVAR
Apparent power	0 – 999.9VA	0.1VA	
	1KVA – 999.9KVA	0.1KVA	
	1MVA – 999.9MVA	0.1MVA	
Active energy	0 – 999.9Wh	0.1Wh	
	1KWh – 999.9KWh	0.1KWh	
	1MWh – 999.9MWh	0.1MWh	
Reactive energy	0 – 999.9VARh	0.1VARh	
	1KVARh – 999.9KVARh	0.1KVARh	
	1MVARh – 999.9MVARh	0.1MVARh	

#### 13.1.5. Cos $\phi$ measurement

Cos $\phi$	Resolution	Uncertainty (expressed in degrees)
0.20	0.01	1.0
0.50		0.7
0.80		0.6

### 13.1.6. Measurement of harmonics

#### Voltage

Range	Accuracy	Resolution
DC – 25h	$\pm(5.0\%+2\text{digit})$	0.1V
26h – 33h	$\pm(10.0\%+2\text{digit})$	
34h – 49h	$\pm(15.0\%+2\text{digit})$	

The voltage harmonics will be null under the following threshold:

- DC: if <1V or <2% of 1<sup>st</sup> harmonic
- 1<sup>st</sup> harmonic: if <2V
- 2<sup>nd</sup> ÷ 49<sup>th</sup>: if <1V or <2% 1<sup>st</sup> harmonic

#### Current

Range	Accuracy	Resolution
DC – 25h	$\pm(5.0\%+2\text{digit})$	0.1A
26h – 33h	$\pm(10.0\%+2\text{digit})$	
34h – 49h	$\pm(15.0\%+2\text{digit})$	

The current harmonics will be null under the following threshold:

- DC: if <2% of 1<sup>st</sup> harmonic or < 0,2% of clamp full scale
- 1<sup>st</sup> harmonic: if < 0,2% of clamp full scale
- 2<sup>nd</sup> ÷ 49<sup>th</sup>: if <2% 1<sup>st</sup> harmonic or < 0,2% of clamp full scale

Setting the **FLEX** option the DC component will be ignored.

### 13.1.7. Frequency measurement

#### Instrument set to 50Hz

Range	Resolution	Accuracy
47 ÷ 53	0,1Hz	$\pm(1.0\%+1\text{digit})$

#### Instrument set to 60Hz

Range	Resolution	Accuracy
57 ÷ 63,6	0,1Hz	$\pm(1.0\%+1\text{digit})$

### 13.1.8. Compliance

DM-IIIS complies with the standards prescribed for:

- class 2 EN61036 – static counters of active energy
- class 3 IEC1268 – static counters of reactive energy

### 13.1.9. Temperature drift

Temperature drift: 0,1 x accuracy/K

### 13.1.10. Safety

The instrument complies to the standards: EN 61010-1 + A2(1996)

Insulation: Class 2

Pollution: 2

Over-voltage category: CAT III 370V~ (Phase-Earth)

CAT III 635V~ (Phase-Phase)

### 13.1.11. General characteristics

#### Mechanical features

Dimensions:	8.9”(L) x 6.5” (La) x 4.1”(H) 225(L) x 165(La) x 105(H) mm
Weight:	3.3 Lb (1.5kg)
Internal power supply	6 batteries 1.5V series AA LR6
Battery Life:	50 hours
External power supply	Use only Amprobe power supply Adapter code DMT-EXTPS
Display:	dot matrix with backlight
Resolution	128 x 128 dots (16384 dots)
Dot size	0.5mm x 0.5mm
Visible area	2.9” x 2.9” (73mm x 73mm)
Sampling speed:	130.21usec a 60Hz.
No. of samples per period	128

#### Clamp (FLEX3)

Maximum diameter of the cable:	5.9” (150 mm)
--------------------------------	---------------

## 13.2. ENVIRONMENT

### 13.2.1. Operating conditions

Reference temperature:	73°F ± 2°F (23°C ± 1°C)
Operating temperature:	32°F to 122°F (0°C to 50 °C)
Relative humidity:	<70%
Storage temperature:	14°F to 140°F (-10°C to 60 °C)
Storage humidity:	<80%

### 13.2.2. EMC

This instrument has been designed in compliance with the EMS standards in force and its compatibility has been tested for EN61326-1 (1997) + A1 (1997).

**This instrument complies with the prescriptions of the European directive on low voltage 73/23/CEE (LVD) and EMC directive 89/336/EEC, amended by 93/68/EEC.**

## 13.3. ACCESSORIES

### 13.3.1. Standard accessories

The package contains:

Description	Model name
Instrument	DM-IIIS
Carrying case	HW1254A
External power supply 12VDC	DMT-EXTPS
3 Flexible clamp meters 1000A / 3000A	FLEX3
4 cables and alligators for voltage measurement	KITENERGY3
1 Software Toplink	TOPLINK
Serial Cable	C232NG1

## 14. APPENDIX 1 – MESSAGES DISPLAYED

Message	Description	Advices ☺
<b>AUTONOM:</b>	Available memory autonomy for the recording which is being effected	
<b>CLEAR ALL? (Enter)</b>	The operator is trying to cancel all the recordings effected	Press ESC in order not to cancel the whole memory, press ENTER to confirm
<b>CLEAR LAST? (Enter)</b>	The operator is trying to cancel the last recording effected	Press ESC in order not to cancel the last recording, press ENTER to confirm
<b>Data saved</b>	The data have been saved	
<b>DATA SIZE:</b>	Dimensions of the stored data	
<b>HOLD</b>	By pressing the proper key, the HOLD function has been activated	Press HOLD again to disable this function
<b>Password:</b>	A recording has been started and at least 5 minutes have passed from the last activity of the instrument (see paragraph 7).	Insert the password: <b>F1, F4, F3, F2</b>
<b>Invalid date</b>	The inserted date is not correct	Check the inserted date
<b>Energy Measuring</b>	The instrument is taking an energy measurement	Press F1 to stop it
<b>Memory Full</b>	The memory of the instrument is full	Cancel some recordings after transferring them to a PC
<b>No ext supply!</b>	A recording has been started without connecting the external power supply	Verify it you really want to start the recording without the external power supply. In that case, press START again.
<b>No parameter sel</b>	A recording has been started without selecting any value to be recorded	Press START/STOP and select at least a value entering the MENU
<b>No Phase selected</b>	Voltage and/or current harmonics have been selected and the corresponding flag has been enabled (HARMONICS ON) but no phase voltage or current has been selected	Select at least one phase voltage and/or current
<b>PASSWORD ERROR</b>	The inserted password is wrong (see paragraph 7)	Check the password
<b>PASSWORD OK</b>	The inserted password is correct	
<b>Please wait</b>	The instrument is waiting for the recording to be started (see paragraph 6)	
<b>Recording</b>	The instrument is recording (see paragraph 6)	
<b>Too many param</b>	More than 63 parameters have been selected (harmonics included) or More than 38 parameters with CO-GENERATION Flag enabled	Deselect some values
<b>Too many record</b>	The quantity of recorded data + Smp exceeds the maximum allowed (35)	Cancel some recordings after transferring them to a PC
<b>ERR: SEQ</b>	The Phase Sequence is not correct.	Check the Phase Sequence connection.
<b>ERR: P-</b>	The active powers shown on the right side of the message are negative	If there isn't a situation of co-generation check if the clamps are properly connected
<b>ERR: SEQ &amp; P-</b>	The active powers shown on the right side of the message are negative and the Phase Sequence is not correct.	If there is not a situation of co-generation, check if the clamps are properly connected / check the Phase Sequence connection.
<b>ERR: CONNECTION</b>	The instrument has detected a wrong connection to Voltage inputs	Check the Voltage connections (see paragraph 11)
<b>Error Vref</b>	The user set a Voltage reference not compatible with voltage at instrument's input.	Check Voltage Reference set in "CONFIG RECORDER"
<b>Error1 ÷ Error 5</b>	Error during Memory Reading	Contact Amprobe assistance

## 15. APPENDIX 2 – RECORDABLE PARAMETERS: SYMBOLS

Symbol	Description
V1, V2, V3	RMS value of the voltage of phase 1, phase 2, phase 3 respectively
V12, V23 V31	Value of phase to phase voltages
I1, I2, I3	RMS value of the current of phase 1, phase 2, phase 3 respectively
IN	RMS value of the current of the neutral
DC	Continuous component of voltage or current
h01 ÷ h49	Harmonic 01 ÷ Harmonic 49 of voltage or current
ThdV	Factor of total harmonic distortion of the voltage (see paragraph 16.2)
ThdI	Factor of total harmonic distortion of the current (see paragraph 16.2)

Pt, P1, P2, P3	Values of the total active power, of phase 1, phase 2, phase 3 respectively
P12, P32	(only for 3 wires measurement) Value of the power measured by the Wattmeter 1-2 and 3-2 respectively (see paragraph 16.3.2).
Qt, Q1, Q2, Q3	Values of the total reactive power, of phase 1, phase 2, phase 3 respectively
Q12, Q32	(only for 3 wires measurement) Value of the power measured by the VARmeter 1-2 and 3-2 respectively (see paragraph 16.3.2).
St, S1, S2, S3	Values of the total apparent power, of phase 1, phase 2, phase 3 respectively
S12, S32	(only for 3 wires measurement) Value of the power measured by the VAmeter 1-2 and 3-2 respectively (see paragraph 16.3.2).
Pft, pf1, pf2, pf3	Value of the total power factors, power factors of phase 1, phase 2, phase 3 respectively
dPft, dpf1, dpf2, dpf3	Values of the total $\cos\phi$ , of phase 1, phase 2, phase 3 respectively

Eat, Ea1, Ea2, Ea3	Values of the total active energy, of phase 1, phase 2, phase 3 respectively
Erit, Eri1, Eri2, Eri3	Values of the total inductive reactive Energy, of phase 1, phase 2, phase 3 respectively
Erct, Erc1, Erc2, Erc3	Values of the total capacitive reactive Energy, of phase 1, phase 2, phase 3 respectively
Est, Es1, Es2, Es3	Values of the total Apparent Energy, of phase 1, phase 2, phase 3 respectively

**16. APPENDIX 3 – THEORETICAL OUTLINES**

**16.1. VOLTAGE ANOMALIES (VOLTAGE SAG AND SURGE)**

The instrument records as voltage anomalies all those rms values, calculated every 10ms, beyond the percent thresholds of Voltage Reference (Vref) set during the programming from ±1% to ±30 % (with steps of 1%). The maximum upper limit percent is reduced as Vref approaches 600V. The Reference must be set to:

Nominal Voltage Phase to Neutral: for Single Phase and 4 wires three phase system

Nominal Voltage Phase to Phase: for 3 wires three phase system

The Instrument will detect Voltage Anomalies if the RMS Voltage Values (calculated every 10ms) beyond the above calculated thresholds. These limits remain unchanged throughout the recording period. When a Voltage anomaly occurs the instrument records:

- The number corresponding to the phase where the anomaly occurred.
- The “direction” of the anomaly: “UP” and “DN” identify respectively voltage drops (sag) and peaks (Surge).
- The date and time of the beginning of the event in the form day, month, year, hour, minutes, seconds, hundredths of second.
- The duration of the event, in seconds with a resolution of 10ms.
- The minimum (or maximum) value of voltage during the event.

**16.2. VOLTAGE AND CURRENT HARMONICS**

**16.2.1. Theory**

Any periodical non-sine wave can be represented as a sum of sinusoidal waves having each a frequency that corresponds to an entire multiple of the fundamental, according to the relation:

$$v(t) = V_0 + \sum_{k=1}^{\infty} V_k \sin(\omega_k t + \phi_k) \tag{1}$$

where:

$V_0$  = Average value of  $v(t)$

$V_1$  = Amplitude of the fundamental of  $v(t)$

$V_k$  = Amplitude of the  $k^{th}$  harmonic of  $v(t)$

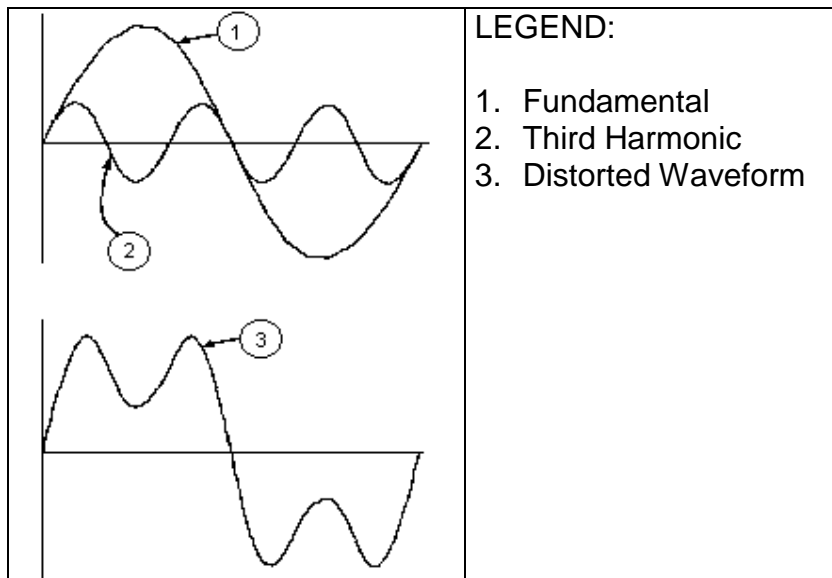

Effect of the sum of 2 multiple frequencies.

In the mains voltage, the fundamental has a frequency of 60 Hz, the second harmonic has a frequency of 120 Hz, and the third harmonic has a frequency of 180 Hz and so on. Harmonic distortion is a constant problem and should not be confused with short events such as sags, surges or fluctuations.

It can be noted that in (1) the index of the sigma is from 1 to the infinite. What happens in reality is that a signal does not have an unlimited number of harmonics: a number always exists after which the harmonics value is negligible. The EN 50160 standard recommends to stop the index in the expression (1) in correspondence of the 40<sup>th</sup> harmonic.

A fundamental element to detect the presence of harmonics is  $T_{hd}$  defined as:

$$THD_v = \frac{\sqrt{\sum_{h=2}^{40} V_h^2}}{V_1}$$

This index takes all the harmonics into account. The higher it is, the more distorted the waveform gets.

### 16.2.2. Limit values for harmonics

EN-50160 fixes the limits for the harmonic voltages, which can be introduced into the network by the power supplier. In normal conditions, during whatever period of a week, 95% if the RMS value of each harmonic voltage, mediated on 10 minutes, will have to be less than or equal to the values stated in the following table.

The total harmonic distortion ( $T_{hd}$ ) of the supply voltage (including all the harmonics up to 40<sup>th</sup> order) must be less than or equal to 8%.

Odd harmonics				Even harmonics	
Not multiple of 3		Multiple of 3		Order h	Relative voltage %Max
Order h	Relative voltage % Max	Order h	Relative voltage % Max		
5	6	3	5	2	2
7	5	9	1,5	4	1
11	3,5	15	0,5	6..24	0,5
13	3	21	0,5		
17	2				
19	1,5				
23	1,5				
25	1,5				

These limits, theoretically applicable only for the supplier of electric energy, provide however a series of reference values within which the harmonics introduced into the network by the users must be contained.

### 16.2.3. Presence of harmonics: causes

Any apparatus that alters the sine wave or uses only a part of such a wave causes distortions to the sine wave and therefore harmonics.

All current signals are in some way distorted. The most common situation is the harmonic distortion caused by non-linear loads such as household appliances, personal computers or speed control units for motors. Harmonic distortion causes significant currents at frequencies that are odd multiples of the fundamental frequency. Harmonic currents affect considerably the neutral wire of electric installations.

In most countries, the mains power is three-phase 50/60Hz with a delta primary and star secondary transformer. The secondary generally provides 230V AC from phase to neutral and 400V AC from phase to phase. Balancing the loads on each phase has always represented a headache for electric systems designers.

Until some ten years ago, in a well-balanced system, the vectorial sum of the currents in the neutral was zero or quite low (given the difficulty of obtaining a perfect balance). The devices were incandescent lights, small motors and other devices that presented linear loads. The result was an essentially sinusoidal current in each phase and a low current on the neutral at a frequency of 50/60Hz.

“Modern” devices such as TV sets, fluorescent lights, video machines and microwave ovens normally draw current for only a fraction of each cycle thus causing non-linear loads and subsequent non-linear currents. All this generates odd harmonics of the 50/60Hz line frequency. For this reason, the current in the transformers of the distribution boxes contains only a 50Hz (or 60Hz) component but also a 150Hz (or 180Hz) component, a 300Hz (or 360Hz) component and other significant components of harmonic up to 750Hz (or 900Hz) and higher.

The vectorial sum of the currents in a well-balanced system that feeds non-linear loads may still be quite low. However, the sum does not eliminate all current harmonics. The odd multiples of the third harmonic (called “TRIPLENS”) are added together in the neutral and can cause overheating, even with balanced loads.

### 16.2.4. Presence of harmonics: consequences

In general, even harmonics, i.e. the 2<sup>nd</sup>, 4<sup>th</sup> etc., do not cause problems. Triple harmonics, odd multiples of three, are added on the neutral (instead of canceling each other) thus creating a condition of overheating of the wire which is extremely dangerous.

Designers should take into consideration the three issues given below when designing a power distribution system that will contain harmonic current:

- The neutral wire must be of sufficient gauge.
- The distribution transformer must have an additional cooling system to continue operating at its rated capacity when not suited to the harmonics. This is necessary because the harmonic current in the neutral wire of the secondary circuit circulates in the delta-connected primary circuit. This circulating harmonic current heats up the transformer.
- Phase harmonic currents are reflected on the primary circuit and continue back to the power source. This can cause distortion of the voltage wave, so that any power factor correction capacitors on the line can be easily overloaded.

The 5<sup>th</sup> and the 11<sup>th</sup> harmonics contrast the current flow through the motors making its' operation harder and shortens their average life.

In general, the higher the ordinal harmonic number, the smaller its energy is and therefore the impact it will have on the devices (except for transformers).



### 16.3. POWER AND POWER FACTOR: DEFINITIONS

In a standard electric installation powered by three sine voltages the following is defined:

Phase Active Power:	(n=1,2,3)	$P_n = V_n \cdot I_n \cdot \cos(\varphi_n)$
Phase Apparent Power:	(n=1,2,3)	$S_n = V_n \cdot I_n$
Phase Reactive Power:	(n=1,2,3)	$Q_n = \sqrt{S_n^2 - P_n^2}$
Phase Power Factor:	(n=1,2,3)	$P_{Fn} = \frac{P_n}{S_n}$
Total Active Power:		$P_{TOT} = P_1 + P_2 + P_3$
Total Reactive Power:		$Q_{TOT} = Q_1 + Q_2 + Q_3$
Total Apparent Power:		$S_{TOT} = \sqrt{P_{TOT}^2 + Q_{TOT}^2}$
Total Power Factor:		$P_{FTOT} = \frac{P_{TOT}}{S_{TOT}}$

where:

$V_n =$  RMS value of voltage between phase n and Neutral.

$I_n =$  RMS value of n phase current.

$f_n =$  Phase displacement angle between voltage and current of n phase.

In presence of distorted voltages and currents the previous relations vary as follows:

Phase Active Power:	(n=1,2,3)	$P_n = \sum_{k=0}^{\infty} V_{kn} I_{kn} \cos(\varphi_{kn})$
Phase Apparent Power:	(n=1,2,3)	$S_n = V_{nN} \cdot I_n$
Phase Reactive Power:	(n=1,2,3)	$Q_n = \sqrt{S_n^2 - P_n^2}$
Phase Power Factor:	(n=1,2,3)	$P_{Fn} = \frac{P_n}{S_n}$
Distorted Power Factor:	(n=1,2,3)	$dPF_n = \cos f_{1n} =$ phase displacement between the fundamentals of voltage and current of n phase
Total Active Power:		$P_{TOT} = P_1 + P_2 + P_3$
Total Reactive Power:		$Q_{TOT} = Q_1 + Q_2 + Q_3$
Total Apparent Power:		$S_{TOT} = \sqrt{P_{TOT}^2 + Q_{TOT}^2}$
Total Power Factor:		$P_{FTOT} = \frac{P_{TOT}}{S_{TOT}}$

where:

$V_{kn} =$  RMS value of kth voltage harmonic between n phase and Neutral.

$I_{kn} =$  RMS value of kth current harmonic of n phase.

$f_{kn} =$  Phase displacement angle between kth voltage harmonic and kth current harmonic of n phase.

**Note:**

It is to be noted that the expression of the phase Reactive Power with non sine waveforms, would be wrong. To understand this, it may be useful to consider that both the presence of harmonics and the presence of reactive power produce, among other effects, an increase of line power losses due to the increased current RMS value. With the above given relation the increasing of power losses due to harmonics is added to that introduced by the presence of reactive power. In effect, even if the two phenomena together contribute to the increase of power losses in line, it is not true in general that these causes of the power losses are in phase between each other and therefore can be added one to the other mathematically.

The above given relation is justified by the relative simplicity of calculation of the same and by the relative discrepancy between the value obtained using this relation and the true value.

It is to be noted moreover, how in case of an electric installation with harmonics, another parameter called distorted Power Factor (dPF) is defined. In practice, this parameter represents the theoretical limit value that can be reached for Power Factor if all the harmonics could be eliminated from the electric installation.

**16.3.1. Conventions on powers and power factors**

As for the recognition of the type of reactive power, of the type of power factor and of the direction of the active power, the below conventions must be applied. The stated angles are those of phase-displacement of the current compared to the voltage (for example, in the first panel the current is in advance from 0° to 90° compared to the voltage):

<b>Equipment under test = Inductive Generator ←</b>			<b>→ Equipment under test = Capacitive Load</b>	
		<b>90°</b>		
	P+ = 0	P - = <b>P</b>	P+ = <b>P</b>	P - = 0
	Pfc+ = -1	Pfc - = -1	Pfc+ = <b>Pf</b>	Pfc - = -1
	Pfi+ = -1	Pfi - = <b>Pf</b>	Pfi+ = -1	Pfi - = -1
	Qc+ = 0	Qc- = 0	Qc+ = <b>Q</b>	Qc- = 0
<b>180°</b>	Qi+ = 0	Qi - = <b>Q</b>	Qi+ = 0	Qi - = 0
		<b>0°</b>		
		<b>270°</b>		
<b>Equipment under test = Capacitive Generator ←</b>			<b>→ Equipment under test = Inductive Load</b>	
	P+ = 0	P - = <b>P</b>	P+ = <b>P</b>	P - = 0
	Pfc+ = -1	Pfc - = <b>Pf</b>	Pfc+ = -1	Pfc - = -1
	Pfi+ = -1	Pfi - = -1	Pfi+ = <b>Pf</b>	Pfi - = -1
	Qc+ = 0	Qc- = <b>Q</b>	Qc+ = 0	Qc- = 0
	Qi+ = 0	Qi - = 0	Qi+ = <b>Q</b>	Qi - = 0

where:

Symbol	Significance	Remarks
P+	Value of the active power +	Positive parameter (user)
Pfc+	Capacitive power factor +	
Pfi+	Inductive power factor +	
Qc+	Value of the capacitive reactive power +	
Qi+	Value of the inductive reactive power +	
P-	Value of the active power -	Negative parameter (generator)
Pfc-	Capacitive power factor -	
Pfi-	Inductive power factor -	
Qc-	Value of the capacitive reactive power -	
Qi-	Value of the inductive reactive power -	

and where:

Value	Significance
P	The active power (positive or negative) is defined in the panel and therefore acquires the value of the active power in that moment.
Q	The reactive power (inductive or capacitive, positive or negative) is defined in the panel and therefore acquires the value of the reactive power in that moment.
Pf	The power factor (inductive or capacitive, positive or negative) is defined in the panel and therefore acquires the value of the power factor in that moment.
0	The active power (positive or negative) or the reactive power (inductive or capacitive, positive or negative) is NOT defined in the panel and therefore acquires a null value.
-1	The power factor (inductive or capacitive, positive or negative) is NOT defined in the panel.

### 16.3.2. 3 phase 3 wire system

In the electrical systems distributed without neutral, the phase voltages and the power factors and phase  $\cos\phi$  lose importance. Only the phase to phase voltages, the phase currents and the total powers remain defined.

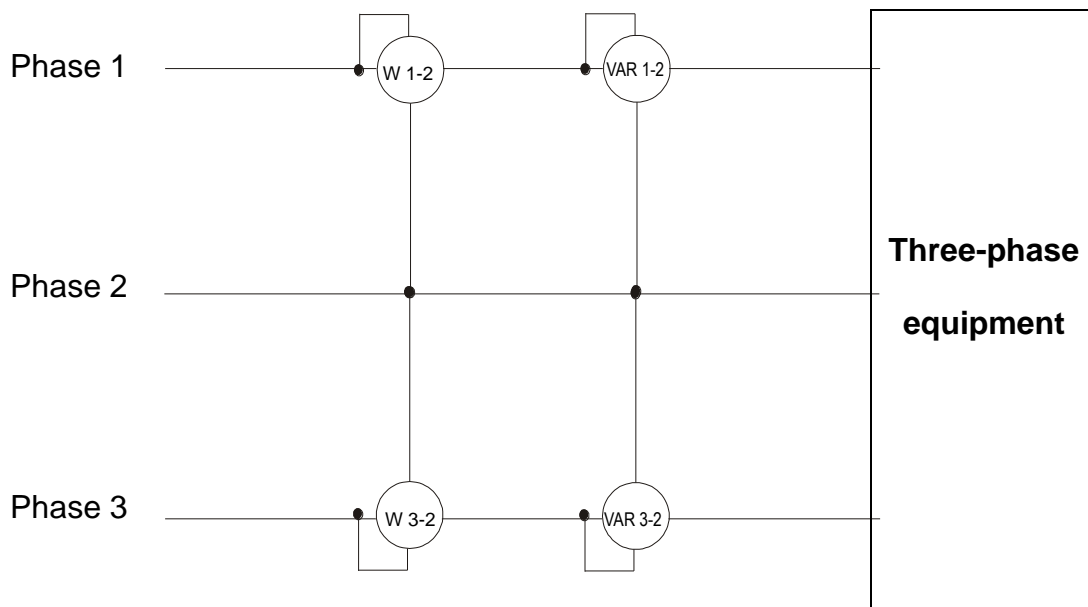

In this case the potential of one of the three phases (for example, phase 2) is taken on as reference potential. The total values of the active, reactive and apparent power are expressed as sum of the indications of the couples of Wattmeters, VARmeters and VAmeters.

$$P_{TOT} = W_{1-2} + W_{3-2}$$

$$Q_{TOT} = VAR_{1-2} + VAR_{3-2}$$

$$S_{TOT} = \sqrt{(W_{1-2} + W_{3-2})^2 + (VAR_{1-2} + VAR_{3-2})^2}$$

## 16.4. MEASURING METHOD: OUTLINES

The instrument is able to measure: voltages, currents, active powers, inductive and capacitive reactive powers, apparent powers, inductive and capacitive power factors, analog or impulse parameters. All these parameters are analyzed in a digital way: for each phase (voltage and current), 6 x 128 samples are acquired on a module of 16 x 20ms, repeated for the three phases.

### 16.4.1. Integration periods

The storage of all the data would require a huge amount of memory.

Therefore, we've tried to find out a storage method that compresses the information to be memorized, while still providing a significant amount of data.

The chosen method is that of integration. After a certain period called the "integration period", which can be set from 5 seconds to 60 minutes, the instrument extracts from the sampled values the following:

- Minimum value of the parameter during the integration period (harmonics excluded)
- Medium value of the parameter (intended as arithmetic average of all the values registered during the integration period)
- Maximum value of the parameter during the integration period (harmonics excluded)

Only this information (repeated for each parameter to be memorized) is saved in the memory along with starting time and date of the integration period.

Once these data are memorized, the instrument restarts to take measurements for a new period.

### 16.4.2. Power factor calculations

According to the standards in force, the medium power factor can't be calculated as average of the instantaneous power factors. It must be obtained from the medium values of active and reactive power.

Each single medium power factor (of phase or total) is therefore calculated, at the end of each integration period, on the medium value of the corresponding powers independently on the fact that they must be registered or not.

Besides, for a better analysis of the type of load present on the line and in order to have terms of comparison when studying the invoicing of the low  $\cos\varphi$ , the values of inductive and capacitive  $\cos\varphi$  are treated as independent parameters.

## **17. AFTER-SALE SERVICE**

### **17.1. WARRANTY**

Congratulations! Your new instrument has been quality crafted according to quality standards and contains quality components and workmanship. It has been inspected for proper operation of all of its functions and tested by qualified factory technicians according to the long-established standards of our company.

Your instrument has a limited warranty against defective materials and/or workmanship for one year from the date of purchase provided that, in the opinion of the factory, the instrument has not been tampered with or taken apart.

**Should your instrument fail due to defective materials, and/or workmanship during this one-year period, a no charge repair or replacement will be made to the original purchaser. Please have your dated bill of sale, which must identify the instrument model number and serial number and call the number listed below:**

**Repair Department  
ATP – Amprobe, TIF, Promax  
Miramar, FL  
Phone: 954-499-5400  
800-327-5060  
Fax: 954-499-5454  
Website: [www.amprobe.com](http://www.amprobe.com)**

**Please obtain an RMA number before returning product for repair.**

Outside the U.S.A. the local representative will assist you. Above limited warranty covers repair and replacement of instrument only and no other obligation is stated or implied.

### **17.2. SERVICE**

If the instrument fails to operate, check battery, test leads, etc and replace as necessary. If the instrument still malfunctions, please call the phone number listed above.