



PM-60
Pocket Meter

Users Manual

- Mode d'emploi
- Bedienungshandbuch
- Manual d'Uso
- Manual de uso



PM-60

Pocket Meter

Users Manual

English

Limited Warranty and Limitation of Liability

Your Amprobe product will be free from defects in material and workmanship for 1 year from the date of purchase. This warranty does not cover fuses, disposable batteries or damage from accident, neglect, misuse, alteration, contamination, or abnormal conditions of operation or handling. Resellers are not authorized to extend any other warranty on Amprobe's behalf. To obtain service during the warranty period, return the product with proof of purchase to an authorized Amprobe Test Tools Service Center or to an Amprobe dealer or distributor. See Repair Section for details. THIS WARRANTY IS YOUR ONLY REMEDY. ALL OTHER WARRANTIES - WHETHER EXPRESS, IMPLIED OR STATUTORY - INCLUDING IMPLIED WARRANTIES OF FITNESS FOR A PARTICULAR PURPOSE OR MERCHANTABILITY, ARE HEREBY DISCLAIMED. MANUFACTURER SHALL NOT BE LIABLE FOR ANY SPECIAL, INDIRECT, INCIDENTAL OR CONSEQUENTIAL DAMAGES OR LOSSES, ARISING FROM ANY CAUSE OR THEORY. Since some states or countries do not allow the exclusion or limitation of an implied warranty or of incidental or consequential damages, this limitation of liability may not apply to you.

Repair

All test tools returned for warranty or non-warranty repair or for calibration should be accompanied by the following: your name, company's name, address, telephone number, and proof of purchase. Additionally, please include a brief description of the problem or the service requested and include the test leads with the meter. Non-warranty repair or replacement charges should be remitted in the form of a check, a money order, credit card with expiration date, or a purchase order made payable to Amprobe® Test Tools.

In-Warranty Repairs and Replacement – All Countries

Please read the warranty statement and check your battery before requesting repair. During the warranty period any defective test tool can be returned to your Amprobe® Test Tools distributor for an exchange for the same or like product. Please check the "Where to Buy" section on www.amprobe.com for a list of distributors near you. Additionally, in the United States and Canada In-Warranty repair and replacement units can also be sent to a Amprobe® Test Tools Service Center (see next page for address).

Non-Warranty Repairs and Replacement – US and Canada

Non-warranty repairs in the United States and Canada should be sent to a Amprobe® Test Tools Service Center. Call Amprobe® Test Tools or inquire at your point of purchase for current repair and replacement rates.

In USA

In Canada

Amprobe Test Tools Amprobe Test Tools

Everett, WA 98203 Mississauga, ON L4Z 1X9

Tel: 888-993-5853 Tel: 905-890-7600

Fax: 425-446-6390 Fax: 905-890-6866

Non-Warranty Repairs and Replacement – Europe

European non-warranty units can be replaced by your Amprobe® Test Tools distributor for a nominal charge. Please check the "Where to Buy" section on www.amprobe.com for a list of distributors near you.

Amprobe® Test Tools Europe

In den Engematten 14

79286 Glottertal, Germany

tel: +49 (0) 7684 8009 - 0

*(Correspondence only – no repair or replacement available from this address. European customers please contact your distributor.)

PM-60 Pocket Meter

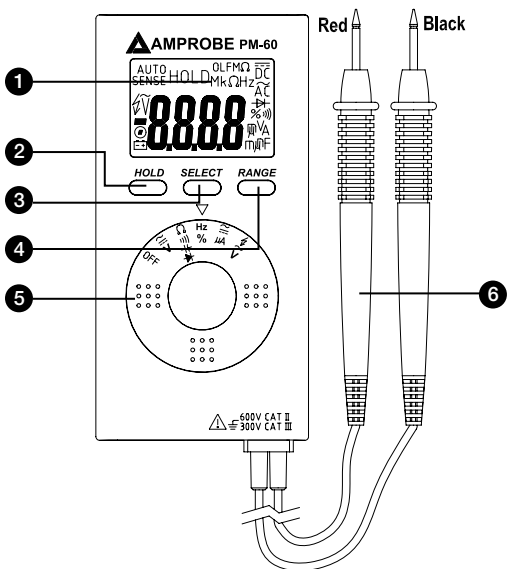











- 1). LCD Display
- 2). Hold function key
- 3). Function selection key
- 4). Range key
- 5). Function Selector
- 6). Test Leads

CONTENTS

SYMBOLS	2
UNPACKING AND INSPECTION	3
INTRODUCTION	3
OPERATION	4
SPECIFICATION	8
MAINTENACE	13
TROUBLE SHOOTING	13
Battery Replacement	14

SYMBOLS

	Warning! Dangerous Voltage (Risk of electric shock).
	Caution ! Refer to the user's manual before using this Meter.
	Double Insulation or Reinforced insulation
	Alternating Current (AC).
	Direct Current (DC).
	Low battery indicator
	Ground (maximum permitted voltage between terminal and ground).
	Please remove all the test leads before performing maintenance, cleaning, battery replacement, fuse replacement, etc
	Complies with European Directives
	Conforms to relevant Australian standards
	Do not dispose of this product as unsorted municipal waste. Contact a qualified recycler for disposal

Warning!

To ensure safe operation and service of the Meter, follow these instructions.

Failure to observe warnings can result in severe injury or death.

- Do not operate this meter in explosive gas (material), combustible gas (material) steam or filled with dust.
- When using test leads or probes, keep your fingers behind the finger guards.

- Use the Meter only as specified in this manual or the protection by the Meter might be impaired.
- Always use proper terminals, switch position and range for measurements.
- Do not apply more than the rated voltage, as marked on Meter, between terminals or between any terminal and earth ground.
- To avoid false readings that can lead to electric shock and injury, replace battery as soon as low battery indicator appears.
- Disconnect circuit power and discharge all high-voltage capacitors before testing resistance, continuity, diodes, or capacitance.
- To reduce the risk of fire or electric shock; do not expose this product to rain or moisture.

UNPACKING AND INSPECTION

Your shipping carton should include:

- 1 PM-60 Meter
- 2 Battery (GPA76P, 1.5V)
- 1 User's Manual

If any of the items are damaged or missing, return the complete package to the place of purchase for an exchange.

INTRODUCTION

This meter PM-60 can be measured voltage, resistance, frequency, capacitance, diode, current (μA) and continuity; It is an electronic measuring instrument that combines several measurement functions in one unit. PM-60 multimeter is portable hand-held devices useful for basic fault finding and field service work. It can be used to troubleshoot electrical problems.

OPERATION

Auto Power Off

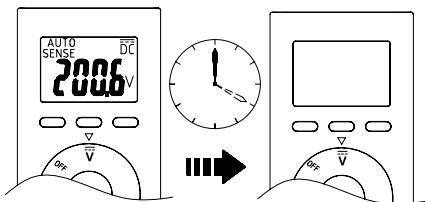

Display Hold

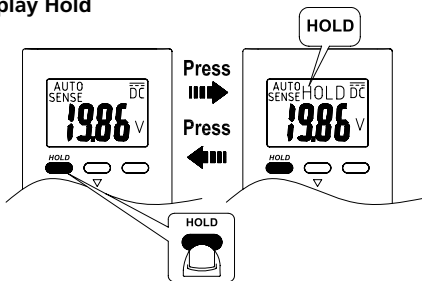

The internal sounder will operate continuously with LCD display flashing in two situations in the Data Hold mode:

1. The Meter measure a signal different from the LCD reading.
2. The measured signal is the same unit as the LCD reading and is larger 50 counts than the LCD reading.

Auto Range / Manual Range

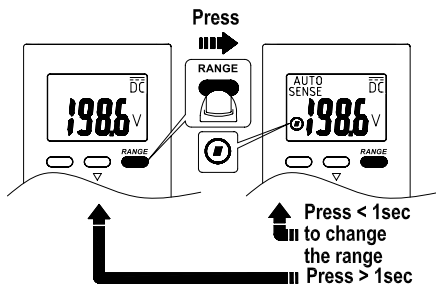

Selecting Function

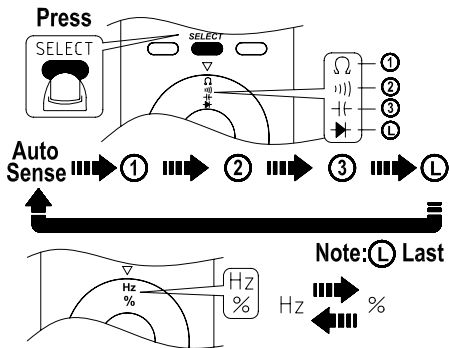

Resistor / Capacitor / Continuity / Diode

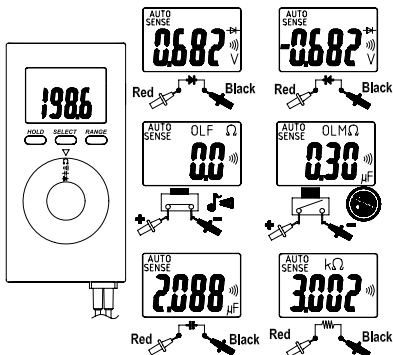

- For better measurement accuracy of small value capacitance, subtract the residual capacitance of the Meter and leads from measurement.
- Under diode mode, LCD displays "bad" when measuring a diode conducted at forward and reverse bias.
- LCD displays capacitance mode when no measurement at Auto-sense mode.
- Under Auto-sense mode, do not measure a broken component, a unknown component, or a component with mixed electrical characteristic, such as measuring a resistor and a capacitor in parallel. The meter may display incorrectly.

AC V / DC / Hz / Duty

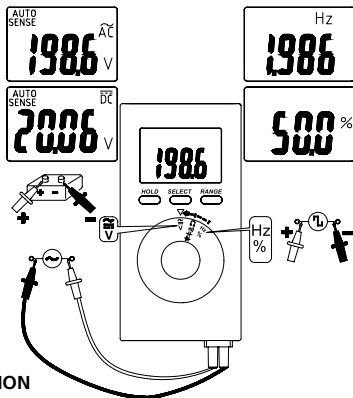

⚠ CAUTION

When connecting the test leads to the circuit or device, connect the black lead first, then connect the red lead ; when removing the test leads, remove the red lead first, then remove the black lead.

Volt Sense

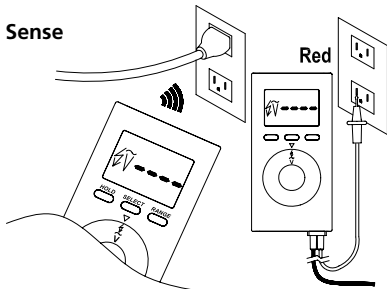

- The number of dashes displaying on the LCD indicates the electric field intensity.

- If no indication, voltage could still be present.
- Using only red test probe to work as mains voltage indicator.

AC A / DC A

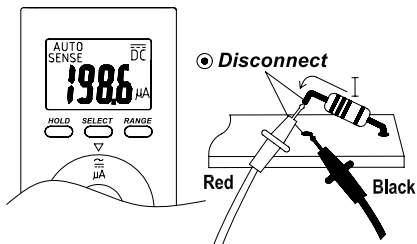

SPECIFICATION

General Specifications

LCD display digits: 4000 counts digit large scale LCD readout.

Measuring rate: 3 times / sec.

Polarity Indication: Automatic, positive implied,

Overrange display: "OL" or "-OL" Unit symbol indication.

Automatic power off time: Approximately 20 minutes after power on.

Low battery indicator: Display on LCD

Power requirement: 1.5V x 2 batteries.

Battery life: 50 hours (GPA76P)

Environmental Conditions

Indoor Use

Calibration: One year calibration cycle

Operating temperature: 0°C/32°F ~ 30°C/86°F (≦ 80% RH)

30°C /86°F ~ 40°C/104°F (≦ 75% RH)

40°C/ 104°F ~ 50°C/122°F (≦ 45%RH)

Storage temperature: -20 to +60°C (-4°F to 140°F), 0 to 80% RH (batteries not fitted).

Temperature coefficient: Add 0.2 x (Specified accuracy) / °C, < 18°C (64.4°F), > 28°C (82.4°F).

Shock vibration: Sinusoidal vibration per MIL-T-28800E (5 ~ 55 Hz, 3g/0.007lb maximum).

Drop Protection: 4 feet drop to hardwood on concrete floor.

Overvoltage category: IEC 61010-1 300V CAT. III., 600V CAT. II.

CAT	Application field
I	The circuits are not connected to mains.
II	The circuits are directly connected to Low-voltage installation.
III	The building installation.
IV	The source of the Low-voltage installation.

Operating altitude: 2000m (6562 ft)

Pollution degree: 2

EMC: EN 61326-1

Dimensions (WxHxD): 56 x 12 x 112 mm (2.2 x 0.5 x 4.4 in)

Weight: 115g (0.25 lb)

Accessories: Battery (installed), carry case and Instruction Card.

Electrical Specifications

Accuracy is \pm (% reading + number of digits) at 23°C/73.4°F \pm 5°C/41°F < 80% RH.

Function	Ranges	Resolution	Accuracy
ACV	400.0mV	0.1mV	± (1.5%+ 5 D)
	4.000V	0.001V	± (0.9%+ 5 D)
	40.00V	0.01V	
	400.0V	0.1V	
	600V	1V	

Frequency Response: 50 ~ 500Hz

AC Conversion Type: AC Coupled Average Sensing, RMS Indication.

Input Impedance: 10MΩ, <100pF.

Overload protection: 600V rms.

Function	Ranges	Resolution	Accuracy
DCV	400.0mV	0.1mV	± (0.7%+ 5 D)
	4.000V	0.001V	± (0.6%+ 2 D)
	40.00V	0.01V	
	400.0V	0.1V	
	600V	1V	± (0.7%+ 5 D)

Input Impedance: 10MΩ, <100pF.

Overload protection: 600V rms.

Function	Ranges	Resolution	Accuracy
ohm	400.0	0.1	± (0.9%+ 5 D)
	4.000K	0.001K	± (0.9%+ 2 D)
	40.00K	0.01K	
	400.0K	0.1K	
	4.000M	0.001M	± (1.5%+ 5 D)
	40.00M*	0.01M	

Open Circuit Voltage: 0.4V

* There is a little rolling less than ± 2%

Overload protection: 600V rms.

CONTINUITY CHECK

Continuity Threshold: Approx. $<50\Omega$

Continuity Indicator: 2.7 KHz Tone Buzzer.

Input Protection: 600V rms..

Function	Ranges	Resolution	Accuracy
Cap	40.00nF	0.01nF	$\pm (5\% + 0.4nF)$
	400.0nF	0.1nF	$\pm (2.9\% + 5D)$
	4.000 μ F	0.001 μ F	
	40.00 μ F	0.01 μ F	
	400.0 μ F	0.1 μ F	

Measuring Time: <30 sec. (400.0 μ F range),
 <10 sec. (40.0 μ F range), <3 sec. (other range)

Overload protection: 600V rms.

Function	Ranges	Resolution	Accuracy
Hz	40.00Hz	0.01Hz	$\pm (0.3\% + 5 D)$
	400.0Hz	0.1Hz	
	4.000KHz	0.001KHz	
	40.00KHz	0.01kHz	

Sensitivity: $> 10Vp-p$ (40KHz range)

$> 1.5Vp-p$ (other range)

The signal must have positive and negative waveform of a cycle.

Max. Sensitivity: 600V rms.

Overload protection: 600V rms.

Function	Ranges	Resolution	Accuracy
%	0.1 - 99.9%	0.1%	$\pm (0.5\% + 10 D)^*$

*: $30\% \leq \text{Duty} \leq 70\%$,

Square Wave (5 Hz ~ 1KHz)**Sensitivity:** 1.5Vp-p**Overload protection:** 600V rms.

Function	Ranges	Resolution	Accuracy
ACA	400.0 μ A	0.1 μ A	\pm (1.5%+ 5 D)
	4.000mA	0.001mA	

Frequency Response: 50 ~ 500Hz**AC Conversion Type:** AC Coupled Average Sensing, RMS Indication.**Input Impedance:** Approx. 3K Ω **Overload protection:** 600V rms.

Function	Ranges	Resolution	Accuracy
DCA	400.0 μ A	0.1 μ A	\pm (0.9%+ 5 D)
	4.000mA	0.001mA	

Input Impedance: Approx. 3K Ω **Overload protection:** 600V rms.**DIODE TEST****Test Current:** Typical. 350 μ A**Open Circuit Voltage:** Max. 1.8V DC**Input Protection:** 600V rm.**CE - EMC: EN61326-1.**

This product complies with requirements of the following European Community Directives: 89/ 336/ EEC (Electromagnetic Compatibility) and 73/ 23/ EEC (Low Voltage) as amended by 93/ 68/ EEC (CE Marking). However, electrical noise or intense electromagnetic fields in the vicinity of the equipment may disturb the measurement circuit. Measuring instruments will also respond to unwanted signals that may be present within the measurement circuit. Users should exercise care and take appropriate precautions to avoid misleading results when making measurements in the presence of electronic interference.

MAINTENANCE

If there appears to be a malfunction during the operation of the meter, the following steps should be performed in order to isolate the cause of the problem.

1. Check the battery. Replace the battery immediately when the "E" symbol appears on the LCD.
2. Review the operating instructions for possible mistakes in operating procedure.

Except for the replacement of the battery, repair of the meter should be performed only by a Factory Authorized Service Center or by other qualified instrument service personnel. The front panel and case can be cleaned with a mild solution of detergent and water. Apply sparingly with a soft cloth and allow to dry completely before using. Do not use aromatic hydrocarbons or chlorinated solvents for cleaning. If the meter is not to be used for periods of longer than 60 days, remove the batteries and store them separately.

Do not attempt to repair this Meter. It contains no user-serviceable parts. Repair or servicing should only be performed by qualified personnel.

TROUBLE SHOOTING

If the instrument fails to operate, check batteries and test leads etc., and replace as necessary. Double check operating procedure as described in this user's manual.

If the instrument voltage-resistance input terminal has subjected to high voltage transient (caused by lightning or switching surge to the system) by accident or abnormal conditions of operation, the series fusible resistors will be blown off (become high impedance) like fuses to protect the user and the instrument. Most measuring functions through this terminal will then be open circuit. The series fusible resistors and the spark

gaps should then be replaced by qualified technician. Refer to the LIMITED WARRANTY section for obtaining warranty or repairing service.

Battery Replacement

Refer to the following figure to replace the batteries:

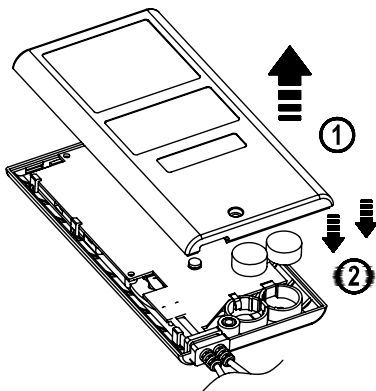

Visit www.Amprobe.com for

- Catalog
- Application notes
- Product specifications
- User manuals



Please Recycle